

SRDA05 Series 8pF 30A Diode Array

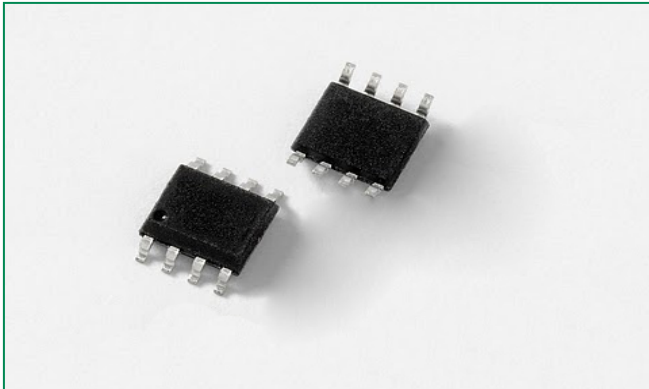

**Description**

The SRDA05 integrates low capacitance rail-to-rail diodes with an additional zener diode to protect I/O pins against ESD and lightning induced surge events. This robust device can safely absorb up to 30A per IEC61000-4-5 ( $t_p=8/20\mu s$ ) without performance degradation and a minimum  $\pm 30kV$  ESD per IEC61000-4-2 international standard. Its low loading capacitance makes it ideal for high-speed interface protection.

**Pinout**

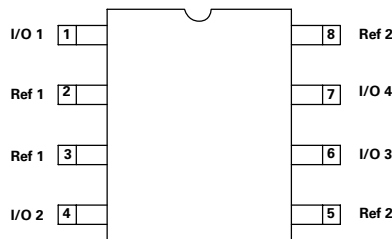

SOIC-8 (Top View)

Note: Pinout diagrams above shown as device footprint on circuit board.

**Features**

- Lightning protection, IEC61000-4-5, 30A (8/20 $\mu s$ )
- EFT, IEC61000-4-4, 50A (5/50ns)
- ESD, IEC61000-4-2,  $\pm 30kV$  contact,  $\pm 30kV$  air
- Low clamping voltage
- Low leakage current
- SOIC-8 surface mount package (JEDEC MS-012)

**Functional Block Diagram**

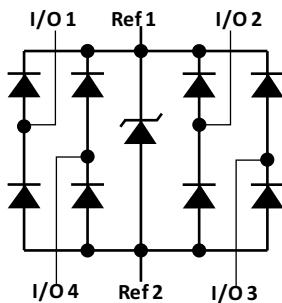

**Applications**

- Tertiary (IC Side) Protection:
  - T1/E1/T3/E3
  - HDSD/SDSL
  - Ethernet
- RS232, RS485
- Video Line Protection
- Security Cameras
- Storage DVRs
- Network Equipment
- Instrumentation, Medical Equipment

**Additional Information**



Datasheet



Resources



Samples

Life Support Note:

**Not Intended for Use in Life Support or Life Saving Applications**

The products shown herein are not designed for use in life sustaining or life saving applications unless otherwise expressly indicated.

**Application Example**

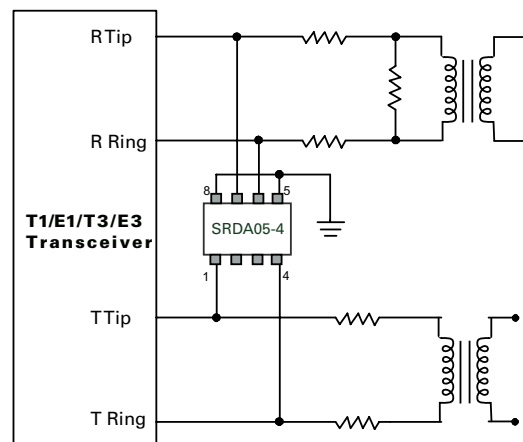

T1/E1/T3/E3 Interface Protection

### Absolute Maximum Ratings

Symbol	Parameter	Value	Units
$P_{pk}$	Peak Pulse Power (8/20 $\mu$ s)	600	W
$I_{pp}$	Peak Pulse Current (8/20 $\mu$ s)	30	A
$T_{op}$	Operating Temperature	-40 to 125	°C
$T_{stor}$	Storage Temperature	-55 to 150	°C

CAUTION: Stresses above those listed in "Absolute Maximum Ratings" may cause permanent damage to the device. This is a stress only rating and operation of the device at these or any other conditions above those indicated in the operational sections of this specification is not implied.

### Thermal Information

Parameter	Rating	Units
SOIC Package	170	°C/W
Operating Temperature Range	-40 to 125	°C
Storage Temperature Range	-55 to 150	°C
Maximum Junction Temperature	150	°C
Maximum Lead Temperature (Soldering 20-40s) (SOIC - Lead Tips Only)	260	°C

### Electrical Characteristics ( $T_{op} = 25^{\circ}\text{C}$ )

Parameter	Symbol	Test Conditions	Min	Typ	Max	Units
Reverse Stand-Off Voltage	$V_{RWM}$	$I_T \leq 1\mu\text{A}$	-	-	5.0	V
Reverse Leakage Current	$I_R$	$V_R = 5\text{V}$	-	-	10	$\mu\text{A}$
Reverse Breakdown Voltage	$V_{BR}$	$I_T = 1\text{mA}$	6	-	-	V
Clamping Voltage, Line-Ground <sup>1</sup>	$V_C$	$I_{pp} = 1\text{A}, t_p = 8/20\mu\text{s}$	-	9.2	-	V
Clamping Voltage, Line-Ground <sup>1</sup>	$V_C$	$I_{pp} = 2\text{A}, t_p = 8/20\mu\text{s}$	-	10.0	-	V
Clamping Voltage, Line-Ground <sup>1</sup>	$V_C$	$I_{pp} = 10\text{A}, t_p = 8/20\mu\text{s}$	-	14.5	-	V
Clamping Voltage, Line-Ground <sup>1</sup>	$V_C$	$I_{pp} = 25\text{A}, t_p = 8/20\mu\text{s}$	-	21.0	-	V
Dynamic Resistance, Line-Ground <sup>1</sup>	$R_{DYN}$	$(V_{C2} - V_{C1}) / (I_{PP2} - I_{PP1})$	-	0.8	-	$\Omega$
ESD Withstand Voltage <sup>1</sup>	$V_{ESD}$	IEC61000-4-2 (Contact Discharge)	$\pm 30$	-	-	kV
		IEC61000-4-2 (Air Discharge)	$\pm 30$	-	-	kV
Diode Capacitance <sup>1</sup>	$C_{I/O-I/O}$	Reverse Bias=0V	-	4.0	-	pF
	$C_{I/O-GND}$	Reverse Bias=0V	-	8.0	-	pF

<sup>1</sup> Parameter is guaranteed by design and/or device characterization.

### Normalized Capacitance vs. Bias Voltage

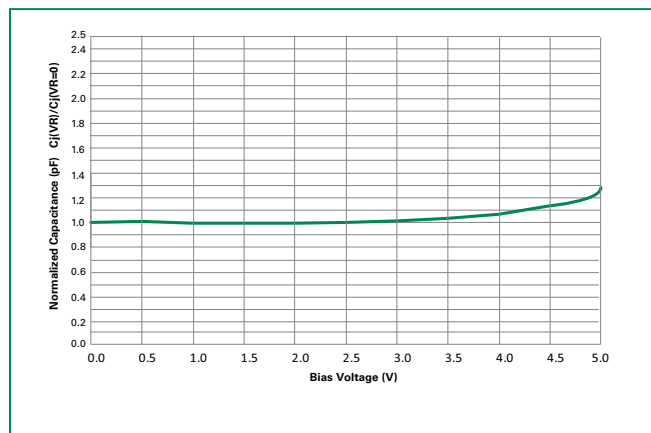

### Non-Repetitive Peak Pulse Power vs. Pulse Time

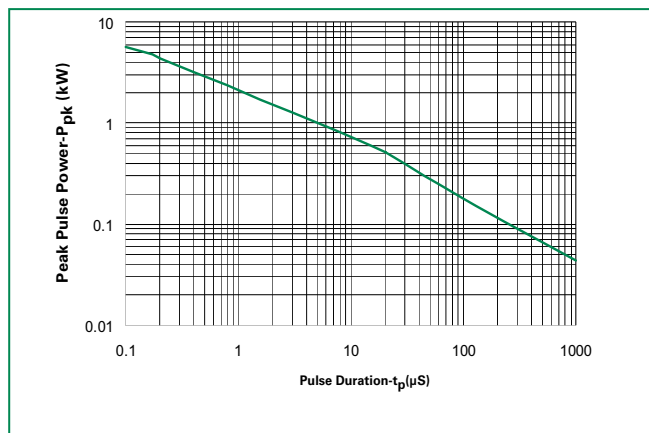

### Clamping Voltage vs. $I_{pp}$

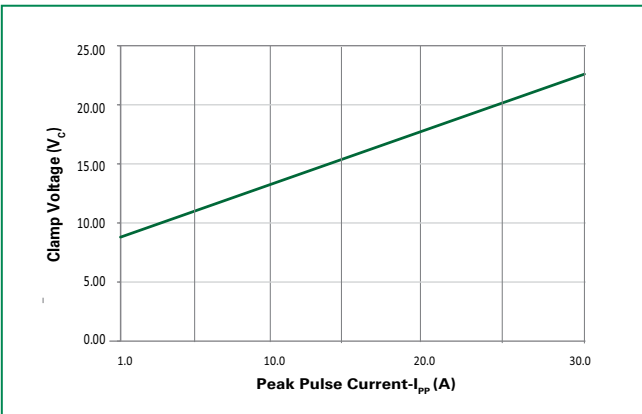

### Power Derating Curve

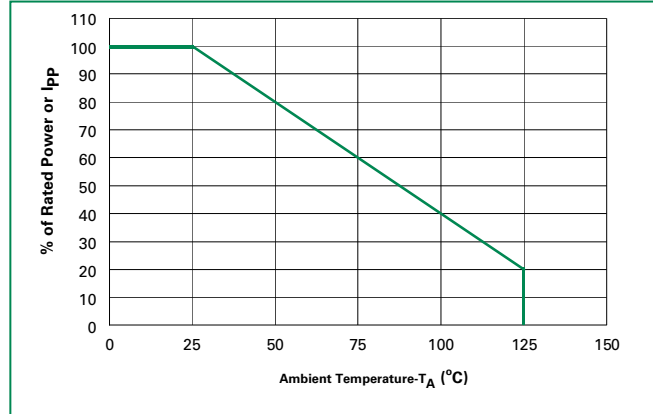

### Pulse Waveform

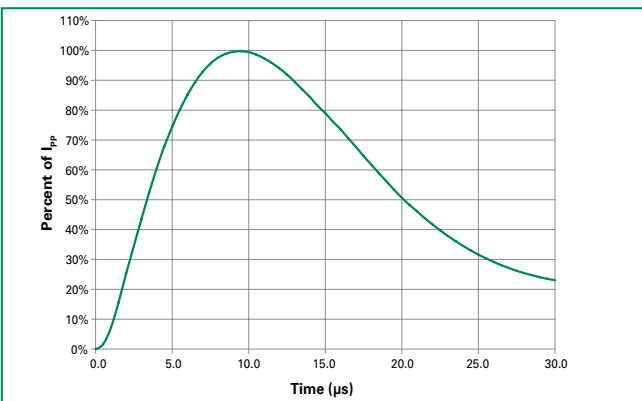

### Product Characteristics

<b>Lead Plating</b>	Matte Tin
<b>Lead Material</b>	Copper Alloy
<b>Lead Coplanarity</b>	0.0004 inches (0.102mm)
<b>Substitute Material</b>	Silicon
<b>Body Material</b>	Molded Epoxy
<b>Flammability</b>	UL 94 V-0

#### Notes :

1. All dimensions are in millimeters
2. Dimensions include solder plating.
3. Dimensions are exclusive of mold flash & metal burr.
4. Blo is facing up for mold and facing down for trim/form, i.e. reverse trim/form.
5. Package surface matte finish VDI 11-13.

### Soldering Parameters

<b>Reflow Condition</b>		Pb – Free assembly
<b>Pre Heat</b>	- Temperature Min ( $T_{s(min)}$ )	150°C
	- Temperature Max ( $T_{s(max)}$ )	200°C
	- Time (min to max) ( $t_s$ )	60 – 180 secs
<b>Average ramp up rate (Liquidus) Temp (<math>T_L</math>) to peak</b>		3°C/second max
<b><math>T_{s(max)}</math> to <math>T_L</math> - Ramp-up Rate</b>		3°C/second max
<b>Reflow</b>	- Temperature ( $T_L$ ) (Liquidus)	217°C
	- Temperature ( $t_l$ )	60 – 150 seconds
<b>Peak Temperature (<math>T_p</math>)</b>		260 <sup>+0/-5</sup> °C
<b>Time within 5°C of actual peak Temperature (<math>t_p</math>)</b>		20 – 40 seconds
<b>Ramp-down Rate</b>		6°C/second max
<b>Time 25°C to peak Temperature (<math>T_p</math>)</b>		8 minutes Max.
<b>Do not exceed</b>		260°C

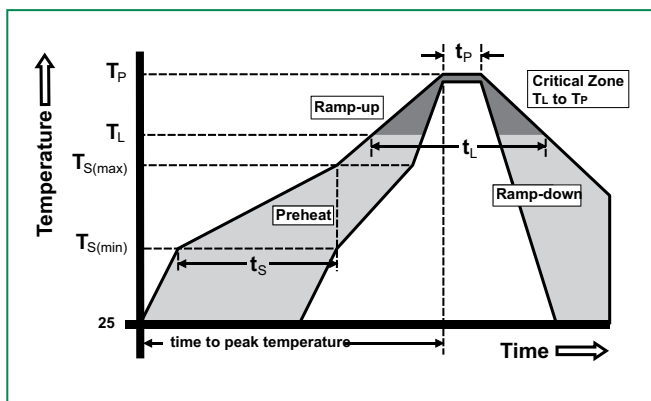

### Ordering Information

Part Number	Package	Marking	Min. Order Qty.
SRDA05-4BTG	SOIC-8	LF SRDA05 SYYWW	2500

**Part Numbering System**

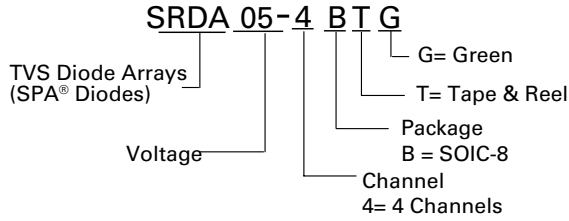

**Part Marking System**

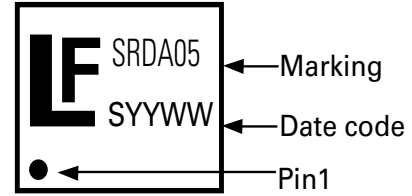

**Package Dimensions – Mechanical Drawings and Recommended Solder Pad Outline**

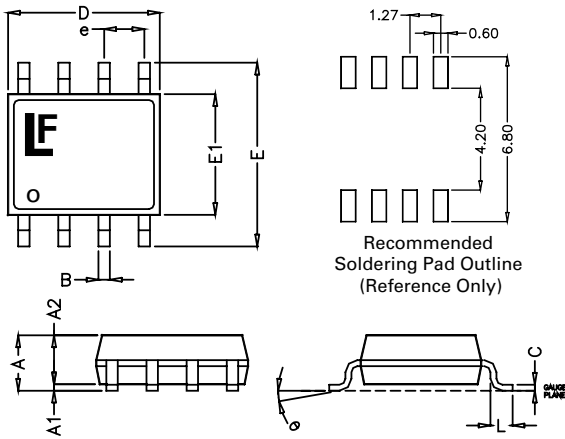

Package	SOIC			
Pins	8			
JEDEC	MS-012			
	Millimetres		Inches	
	Min	Max	Min	Max
<b>A</b>	1.35	1.75	0.053	0.069
<b>A1</b>	0.10	0.25	0.004	0.010
<b>A2</b>	1.25	1.65	0.050	0.065
<b>B</b>	0.31	0.51	0.012	0.020
<b>c</b>	0.17	0.25	0.007	0.010
<b>D</b>	4.70	5.10	0.185	0.201
<b>E</b>	5.80	6.20	0.228	0.244
<b>E1</b>	3.80	4.00	0.150	0.157
<b>e</b>	1.27 BSC		0.050 BSC	
<b>L</b>	0.40	1.27	0.016	0.050

**Embossed Carrier Tape & Reel Specification – SOIC Package**

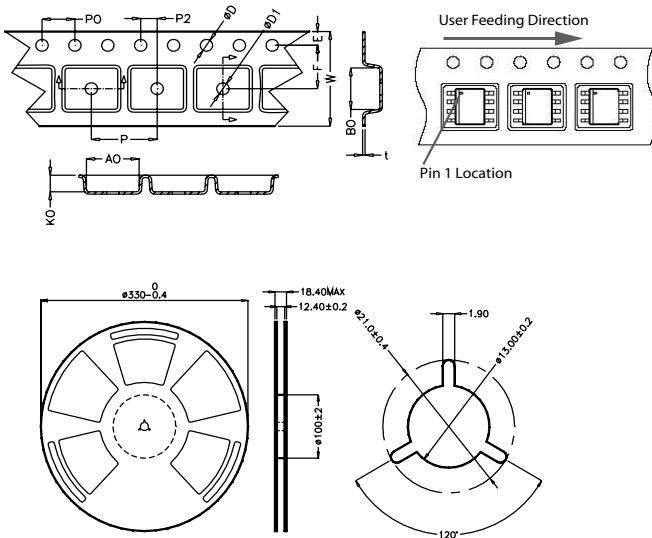

	Millimetres		Inches	
	Min	Max	Min	Max
<b>E</b>	1.65	1.85	0.065	0.073
<b>F</b>	5.4	5.6	0.213	0.22
<b>P2</b>	1.95	2.05	0.077	0.081
<b>D</b>	1.5	1.6	0.059	0.063
<b>D1</b>	1.50 Min		0.059 Min	
<b>P0</b>	3.9	4.1	0.154	0.161
<b>10P0</b>	40.0 ± 0.20		1.574 ± 0.008	
<b>W</b>	11.9	12.1	0.468	0.476
<b>P</b>	7.9	8.1	0.311	0.319
<b>A0</b>	6.3	6.5	0.248	0.256
<b>B0</b>	5.1	5.3	0.2	0.209
<b>K0</b>	2	2.2	0.079	0.087
<b>t</b>	0.30 ± 0.05		0.012 ± 0.002	

**Disclaimer Notice - Information furnished is believed to be accurate and reliable. However, users should independently evaluate the suitability of and test each product selected for their own applications. Littelfuse products are not designed for, and may not be used in, all applications. Read complete Disclaimer Notice at [www.littelfuse.com/disclaimer-electronics](http://www.littelfuse.com/disclaimer-electronics).**