

C4520C0G3F680K200KA

TDK Item Description : C4520C0G3F680KT****



Application & Main Feature

Commercial Grade (High Voltage (1000V and over))

Series

C4520 [EIA CC1808]

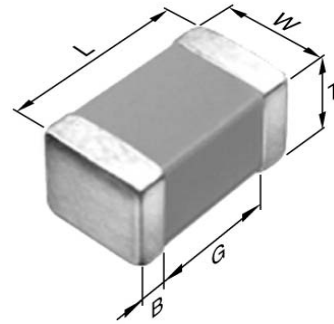

Dimensions

L 4.50mm +/-0.4mm
W 2.00mm +/-0.2mm
T 2.00mm +/-0.2mm
B 0.20mm Min.
G

Temperature Characteristic

C0G (-55 to 125 degC 0+/-30ppm/degC)

Rated Voltage

3F (3000Vdc)

Capacitance

68pF

Capacitance Tolerance

K (+/-10%)

Q Factor

1000 Min.

Insulation Resistance

10Gohm Min.

AEC-Q200

Not Applicable

|Z|, ESR vs. Freq. Characteristics

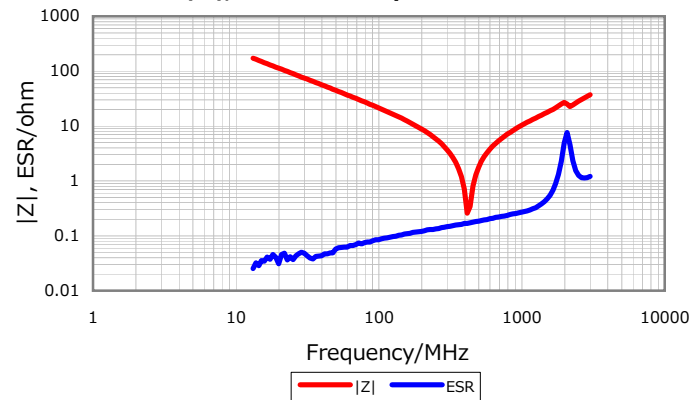

DC Bias Characteristic

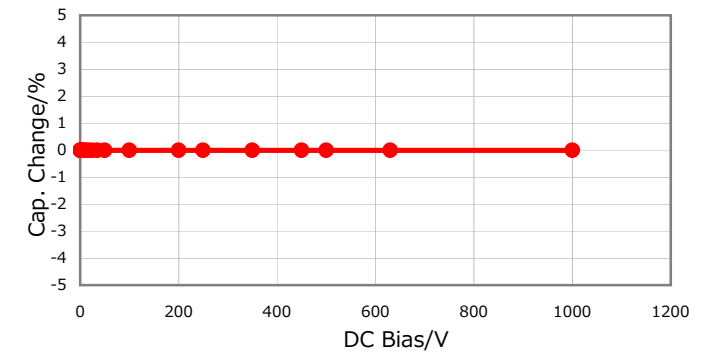

Cap. vs. Freq. Characteristic

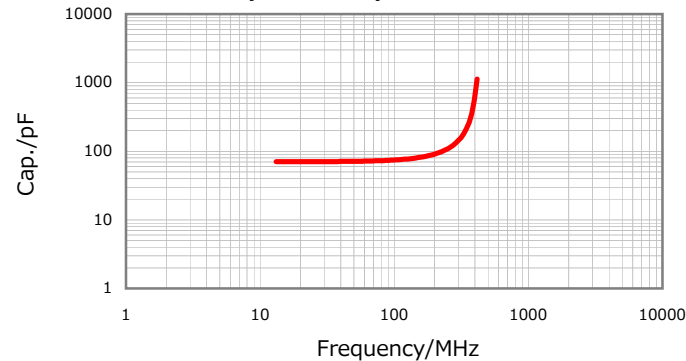

Temperature Characteristics

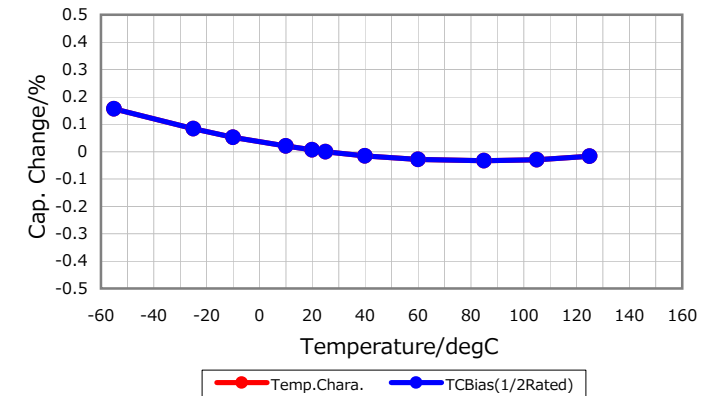

Characterization Sheet (Multilayer Ceramic Chip Capacitors)



All specifications are subject to change without notice.

January 4, 2016