

72-Mbit (2M × 36) Flow-Through SRAM

Features

- Supports 133 MHz bus operations
- 2M × 36 common I/O
- 3.3 V core power supply (V_{DD})
- 2.5 V or 3.3 V I/O supply (V_{DDQ})
- Fast clock to output time
 - 6.5 ns (133 MHz version)
- Provide high performance 2-1-1-1 access rate
- User selectable burst counter supporting Intel® Pentium® interleaved or linear burst sequences
- Separate processor and controller address strobes
- Synchronous self timed write
- Asynchronous output enable
- CY7C1481BV33 available in JEDEC standard Pb-free 100-pin TQFP, Pb-free and non Pb-free 165-ball FBGA package.
- IEEE 1149.1 JTAG compatible boundary scan
- ZZ sleep mode option

Functional Description

The CY7C1481BV33 is a 3.3 V, 2M × 36 synchronous flow through SRAM designed to interface with high speed microprocessors with minimum glue logic. Maximum access delay from clock rise is 6.5 ns (133 MHz version). A 2-bit on-chip counter captures the first address in a burst and increments the address automatically for the rest of the burst access. All synchronous inputs are gated by registers controlled by a positive edge triggered Clock Input (CLK). The synchronous inputs include all addresses, all data inputs, address pipelining Chip Enable (CE_1), depth expansion Chip Enables (CE_2 and CE_3), Burst Control inputs ($ADSC$, $ADSP$, and ADV), Write Enables (BW_x and BWE), and Global Write (GW). Asynchronous inputs include the Output Enable (OE) and the ZZ pin.

The CY7C1481BV33 enables either interleaved or linear burst sequences, selected by the MODE input pin. A HIGH selects an interleaved burst sequence, while a LOW selects a linear burst sequence. Burst accesses are initiated with the Processor Address Strobe ($ADSP$) or the cache Controller Address Strobe ($ADSC$) inputs. Address advancement is controlled by the Address Advancement (ADV) input.

Addresses and chip enables are registered at rising edge of clock when either Address Strobe Processor ($ADSP$) or Address Strobe Controller ($ADSC$) are active. Subsequent burst addresses can be internally generated as controlled by the Advance pin (ADV).

The CY7C1481BV33 operates from a +3.3 V core power supply while all outputs may operate with either a +2.5 V or +3.3 V supply. All inputs and outputs are JEDEC standard JESD8-5 compatible.

For a complete list of related documentation, click [here](#).

Selection Guide

Description	133 MHz	Unit
Maximum Access Time	6.5	ns
Maximum Operating Current	335	mA
Maximum CMOS Standby Current	150	mA

Logic Block Diagram – CY7C1481BV33

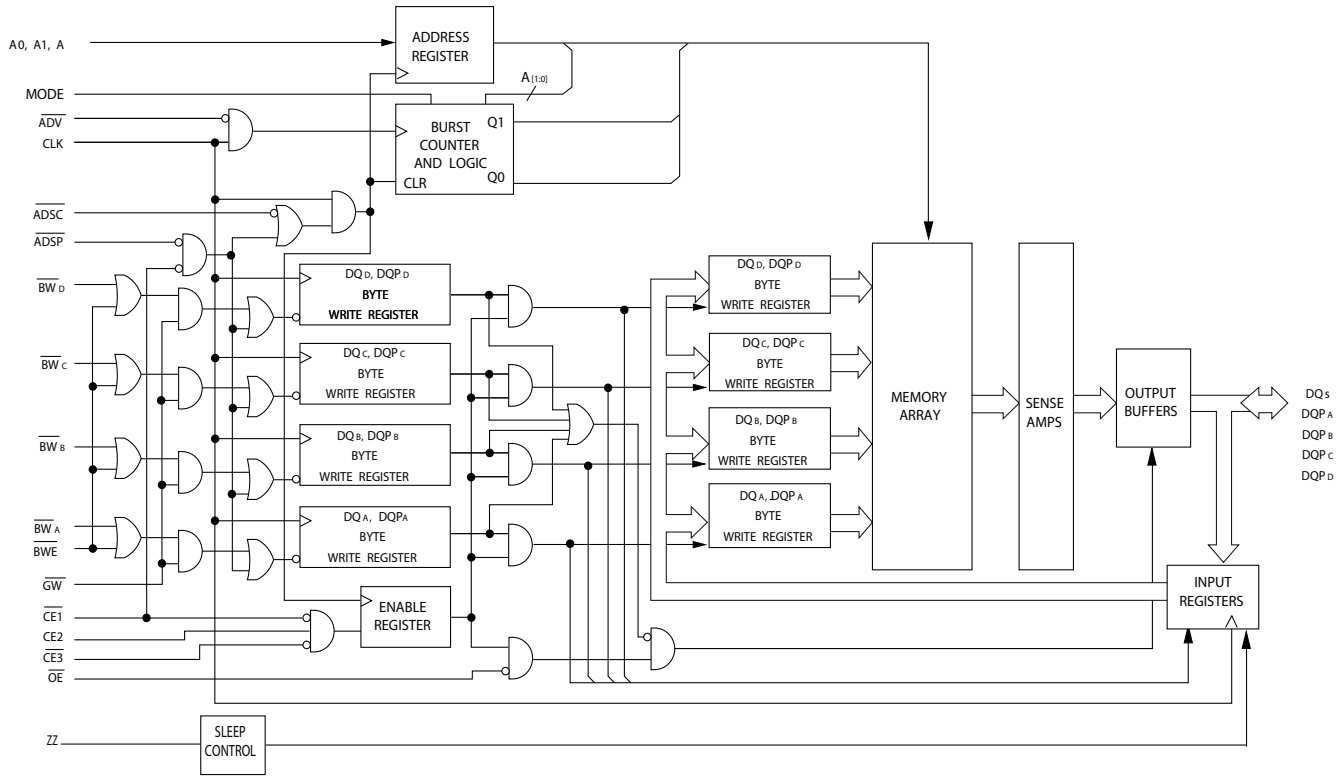

Contents

Pin Configurations	4	TAP DC Electrical Characteristics	
Pin Definitions	6	and Operating Conditions	16
Functional Overview	8	Identification Register Definitions	17
Single Read Accesses	8	Scan Register Sizes	17
Single Write Accesses Initiated by ADSP	8	Identification Codes	17
Single Write Accesses Initiated by ADSC	8	Boundary Scan Exit Order	18
Burst Sequences	8	Maximum Ratings	19
Sleep Mode	8	Operating Range	19
Interleaved Burst Address Table	8	Electrical Characteristics	19
Linear Burst Address Table	8	Capacitance	20
ZZ Mode Electrical Characteristics	9	Thermal Resistance	20
Truth Table	9	AC Test Loads and Waveforms	20
Truth Table for Read/Write	10	Switching Characteristics	21
IEEE 1149.1 Serial Boundary Scan (JTAG)	11	Timing Diagrams	22
Disabling the JTAG Feature	11	Ordering Information	26
Test Access Port (TAP)	11	Ordering Code Definitions	26
PERFORMING A TAP RESET	11	Package Diagrams	27
TAP REGISTERS	11	Acronyms	29
TAP Instruction Set	11	Document Conventions	29
TAP Controller State Diagram	13	Units of Measure	29
TAP Controller Block Diagram	14	Document History Page	30
TAP Timing	15	Sales, Solutions, and Legal Information	31
TAP AC Switching Characteristics	15	Worldwide Sales and Design Support	31
3.3 V TAP AC Test Conditions	16	Products	31
3.3 V TAP AC Output Load Equivalent	16	PSoC@Solutions	31
2.5 V TAP AC Test Conditions	16	Cypress Developer Community	31
2.5 V TAP AC Output Load Equivalent	16	Technical Support	31

Pin Configurations (continued)

Figure 2. 165-ball FBGA (15 × 17 × 1.4 mm) pinout
CY7C1481BV33 (2M × 36)

	1	2	3	4	5	6	7	8	9	10	11
A	NC/288M	A	\overline{CE}_1	\overline{BW}_C	\overline{BW}_B	\overline{CE}_3	\overline{BWE}	\overline{ADSC}	\overline{ADV}	A	NC
B	NC/144M	A	CE_2	\overline{BW}_D	\overline{BW}_A	CLK	\overline{GW}	\overline{OE}	\overline{ADSP}	A	NC/576M
C	DQP _C	NC	V _{DDQ}	V _{SS}	V _{SS}	V _{SS}	V _{SS}	V _{SS}	V _{DDQ}	NC/1G	DQP _B
D	DQ _C	DQ _C	V _{DDQ}	V _{DD}	V _{SS}	V _{SS}	V _{SS}	V _{DD}	V _{DDQ}	DQ _B	DQ _B
E	DQ _C	DQ _C	V _{DDQ}	V _{DD}	V _{SS}	V _{SS}	V _{SS}	V _{DD}	V _{DDQ}	DQ _B	DQ _B
F	DQ _C	DQ _C	V _{DDQ}	V _{DD}	V _{SS}	V _{SS}	V _{SS}	V _{DD}	V _{DDQ}	DQ _B	DQ _B
G	DQ _C	DQ _C	V _{DDQ}	V _{DD}	V _{SS}	V _{SS}	V _{SS}	V _{DD}	V _{DDQ}	DQ _B	DQ _B
H	NC	NC	NC	V _{DD}	V _{SS}	V _{SS}	V _{SS}	V _{DD}	NC	NC	ZZ
J	DQ _D	DQ _D	V _{DDQ}	V _{DD}	V _{SS}	V _{SS}	V _{SS}	V _{DD}	V _{DDQ}	DQ _A	DQ _A
K	DQ _D	DQ _D	V _{DDQ}	V _{DD}	V _{SS}	V _{SS}	V _{SS}	V _{DD}	V _{DDQ}	DQ _A	DQ _A
L	DQ _D	DQ _D	V _{DDQ}	V _{DD}	V _{SS}	V _{SS}	V _{SS}	V _{DD}	V _{DDQ}	DQ _A	DQ _A
M	DQ _D	DQ _D	V _{DDQ}	V _{DD}	V _{SS}	V _{SS}	V _{SS}	V _{DD}	V _{DDQ}	DQ _A	DQ _A
N	DQP _D	NC	V _{DDQ}	V _{SS}	NC	A	NC	V _{SS}	V _{DDQ}	NC	DQP _A
P	NC	A	A	A	TDI	A1	TDO	A	A	A	A
R	MODE	A	A	A	TMS	A0	TCK	A	A	A	A

Pin Definitions

Pin Name	I/O	Description
A ₀ , A ₁ , A	Input-Synchronous	Address Inputs Used to Select One of the Address Locations. Sampled at the rising edge of the CLK if ADSP or ADSC is active LOW, and \overline{CE}_1 , CE ₂ , and \overline{CE}_3 are sampled active. A _[1:0] feed the 2-bit counter.
\overline{BW}_A , \overline{BW}_B , \overline{BW}_C , \overline{BW}_D	Input-Synchronous	Byte Write Select Inputs, Active LOW. Qualified with \overline{BWE} to conduct byte writes to the SRAM. Sampled on the rising edge of CLK.
\overline{GW}	Input-Synchronous	Global Write Enable Input, Active LOW. When asserted LOW on the rising edge of CLK, a global write is conducted (ALL bytes are written, regardless of the values on \overline{BW}_X and \overline{BWE}).
CLK	Input-Clock	Clock Input. Captures all synchronous inputs to the device. Also used to increment the burst counter when ADV is asserted LOW during a burst operation.
\overline{CE}_1	Input-Synchronous	Chip Enable 1 Input, Active LOW. Sampled on the rising edge of CLK. Used in conjunction with CE ₂ and \overline{CE}_3 to select or deselect the device. ADSP is ignored if \overline{CE}_1 is HIGH. \overline{CE}_1 is sampled only when a new external address is loaded.
CE ₂	Input-Synchronous	Chip Enable 2 Input, Active HIGH. Sampled on the rising edge of CLK. Used in conjunction with \overline{CE}_1 and CE ₃ to select or deselect the device. CE ₂ is sampled only when a new external address is loaded.
\overline{CE}_3	Input-Synchronous	Chip Enable 3 Input, Active LOW. Sampled on the rising edge of CLK. Used in conjunction with \overline{CE}_1 and CE ₂ to select or deselect the device. \overline{CE}_3 is sampled only when a new external address is loaded.
\overline{OE}	Input-Asynchronous	Output Enable, Asynchronous Input, Active LOW. Controls the direction of the I/O pins. When LOW, the I/O pins behave as outputs. When deasserted HIGH, I/O pins are tri-stated, and act as input data pins. OE is masked during the first clock of a read cycle when emerging from a deselected state.
ADV	Input-Synchronous	Advance Input Signal, Sampled on the Rising Edge of CLK. When asserted, it automatically increments the address in a burst cycle.
ADSP	Input-Synchronous	Address Strobe from Processor, Sampled on the Rising Edge of CLK, Active LOW. When asserted LOW, addresses presented to the device are captured in the address registers. A _[1:0] are also loaded into the burst counter. When ADSP and ADSC are both asserted, only ADSP is recognized. ADSP is ignored when \overline{CE}_1 is deasserted HIGH.
ADSC	Input-Synchronous	Address Strobe from Controller, Sampled on the Rising Edge of CLK, Active LOW. When asserted LOW, addresses presented to the device are captured in the address registers. A _[1:0] are also loaded into the burst counter. When ADSP and ADSC are both asserted, only ADSP is recognized.
\overline{BWE}	Input-Synchronous	Byte Write Enable Input, Active LOW. Sampled on the rising edge of CLK. This signal must be asserted LOW to conduct a byte write.
ZZ	Input-Asynchronous	ZZ “Sleep” Input, Active HIGH. When asserted HIGH, places the device in a non time-critical “sleep” condition with data integrity preserved. For normal operation, this pin must be LOW or left floating. ZZ pin has an internal pull down.
DQ _s	I/O-Synchronous	Bidirectional Data I/O Lines. As inputs, they feed into an on-chip data register that is triggered by the rising edge of CLK. As outputs, they deliver the data contained in the memory location specified by the addresses presented during the previous clock rise of the read cycle. The direction of the pins is controlled by OE. When OE is asserted LOW, the pins behave as outputs. When HIGH, DQ _s and DQP _x are placed in a tri-state condition. The outputs are automatically tri-stated during the data portion of a write sequence, the first clock when emerging from a deselected state, and when the device is deselected, regardless of the state of OE.
DQP _x	I/O-Synchronous	Bidirectional Data Parity I/O Lines. Functionally, these signals are identical to DQ _s . During write sequences, DQP _x is controlled by \overline{BW}_X correspondingly.
MODE	Input-Static	Selects Burst Order. When tied to GND, selects linear burst sequence. When tied to V _{DD} or left floating, selects interleaved burst sequence. This is a strap pin and must remain static during device operation. Mode Pin has an internal pull up.

Pin Definitions (continued)

Pin Name	I/O	Description
V _{DD}	Power Supply	Power Supply Inputs to the Core of the Device.
V _{DDQ}	I/O Power Supply	Power Supply for the I/O Circuitry.
V _{SS}	Ground	Ground for the Core of the Device.
V _{SSQ} ^[1]	I/O Ground	Ground for the I/O Circuitry.
TDO	JTAG Serial Output Synchronous	Serial Data-Out to the JTAG Circuit. Delivers data on the negative edge of TCK. If the JTAG feature is not used, this pin must be left unconnected. This pin is not available on TQFP packages.
TDI	JTAG Serial Input Synchronous	Serial Data-In to the JTAG Circuit. Sampled on the rising edge of TCK. If the JTAG feature is not used, this pin can be left floating or connected to V _{DD} through a pull up resistor. This pin is not available on TQFP packages.
TMS	JTAG Serial Input Synchronous	Serial Data-In to the JTAG Circuit. Sampled on the rising edge of TCK. If the JTAG feature is not used, this pin can be disconnected or connected to V _{DD} . This pin is not available on TQFP packages.
TCK	JTAG Clock	Clock Input to the JTAG Circuit. If the JTAG feature is not used, this pin must be connected to V _{SS} . This pin is not available on TQFP packages.
NC	–	No Connects. Not internally connected to the die. 144M, 288M, 576M, and 1G are address expansion pins and are not internally connected to the die.

Note

1. Applicable for TQFP package. For BGA package V_{SS} serves as ground for the core and the I/O circuitry.

Functional Overview

All synchronous inputs pass through input registers controlled by the rising edge of the clock. Maximum access delay from the clock rise (t_{CDV}) is 6.5 ns (133 MHz device).

The CY7C1481BV33 supports secondary cache in systems using either a linear or interleaved burst sequence. The interleaved burst order supports Pentium and i486™ processors. The linear burst sequence is suited for processors that use a linear burst sequence. The burst order is user selectable and is determined by sampling the MODE input. Accesses are initiated with either the Processor Address Strobe (ADSP) or the Controller Address Strobe (ADSC). Address advancement through the burst sequence is controlled by the ADV input. A 2-bit on-chip wraparound burst counter captures the first address in a burst sequence and automatically increments the address for the rest of the burst access.

Byte write operations are qualified with the Byte Write Enable (BWE) and Byte Write Select (BW_X) inputs. A Global Write Enable (GW) overrides all byte write inputs and writes data to all four bytes. All writes are simplified with on-chip synchronous self timed write circuitry.

Three synchronous Chip Selects (\overline{CE}_1 , CE_2 , \overline{CE}_3) and an asynchronous Output Enable (OE) provide easy bank selection and output tri-state control. ADSP is ignored if CE_1 is HIGH.

Single Read Accesses

A single read access is initiated when the following conditions are satisfied at clock rise: (1) \overline{CE}_1 , CE_2 , and \overline{CE}_3 are all asserted active, and (2) ADSP or ADSC is asserted LOW (if the access is initiated by ADSC, the write inputs must be deasserted during this first cycle). The address presented to the address inputs is latched into the address register and the burst counter/control logic. It is then presented to the memory core. If the OE input is asserted LOW, the requested data is available at the data outputs a maximum to t_{CDV} after clock rise. ADSP is ignored if CE_1 is HIGH.

Single Write Accesses Initiated by ADSP

This access is initiated when the following conditions are satisfied at clock rise: (1) \overline{CE}_1 , CE_2 , \overline{CE}_3 are all asserted active, and (2) ADSP is asserted LOW. The addresses presented are loaded into the address register and the burst inputs (\overline{GW} , \overline{BWE} , and \overline{BW}_X) are ignored during this first clock cycle. If the write inputs are asserted active (see Truth Table for Read/Write on page 10 for appropriate states that indicate a write) on the next clock rise, the appropriate data is latched and written into the device. The device allows byte writes. All I/Os are tri-stated during a byte write. Because this is a common I/O device, the asynchronous OE input signal must be deasserted and the I/Os must be tri-stated prior to the presentation of data to DQ_s. As a safety precaution, the data lines are tri-stated after a write cycle is detected, regardless of the state of OE.

Single Write Accesses Initiated by ADSC

This write access is initiated when the following conditions are satisfied at clock rise: (1) \overline{CE}_1 , CE_2 , and \overline{CE}_3 are all asserted active, (2) ADSC is asserted LOW, (3) ADSP is deasserted

HIGH, and (4) the write input signals (\overline{GW} , \overline{BWE} , and \overline{BW}_X) indicate a write access. ADSC is ignored if ADSP is active LOW.

The addresses presented are loaded into the address register and the burst counter/control logic and delivered to the memory core. The information presented to DQ_s is written into the specified address location. The device allows byte writes. All I/Os are tri-stated when a write is detected, even a byte write. Because this is a common I/O device, the asynchronous OE input signal must be deasserted and the I/Os must be tri-stated before the data is presented to DQ_s. As a safety precaution, the data lines are tri-stated after a write cycle is detected, regardless of the state of OE.

Burst Sequences

The CY7C1481BV33 provides an on-chip 2-bit wraparound burst counter inside the SRAM. The burst counter is fed by A[1:0], and can follow either a linear or interleaved burst order. The burst order is determined by the state of the MODE input. A LOW on MODE selects a linear burst sequence. A HIGH on MODE selects an interleaved burst order. Leaving MODE unconnected causes the device to default to an interleaved burst sequence.

Sleep Mode

The ZZ input pin is asynchronous. Asserting ZZ places the SRAM in a power conservation “sleep” mode. Two clock cycles are required to enter into or exit from this “sleep” mode. While in this mode, data integrity is guaranteed.

Accesses pending when entering the “sleep” mode are not considered valid nor is the completion of the operation guaranteed.

The device must be deselected before entering the “sleep” mode. CE_1 , CE_2 , \overline{CE}_3 , ADSP, and ADSC must remain inactive for the duration of t_{ZZREC} after the ZZ input returns LOW.

Interleaved Burst Address Table

(MODE = Floating or V_{DD})

First Address A1:A0	Second Address A1:A0	Third Address A1:A0	Fourth Address A1:A0
00	01	10	11
01	00	11	10
10	11	00	01
11	10	01	00

Linear Burst Address Table

(MODE = GND)

First Address A1:A0	Second Address A1:A0	Third Address A1:A0	Fourth Address A1:A0
00	01	10	11
01	10	11	00
10	11	00	01
11	00	01	10

ZZ Mode Electrical Characteristics

Parameter	Description	Test Conditions	Min	Max	Unit
I_{DDZZ}	Sleep mode standby current	$ZZ \geq V_{DD} - 0.2 V$	–	150	mA
t_{ZZS}	Device operation to ZZ	$ZZ \geq V_{DD} - 0.2 V$	–	$2t_{CYC}$	ns
t_{ZZREC}	ZZ recovery time	$ZZ \leq 0.2 V$	$2t_{CYC}$	–	ns
t_{ZZI}	ZZ active to sleep current	This parameter is sampled	–	$2t_{CYC}$	ns
t_{RZZI}	ZZ inactive to exit sleep current	This parameter is sampled	0	–	ns

Truth Table

The truth table for CY7C1481BV33 follows. [2, 3, 4, 5, 6]

Cycle Description	Address Used	CE ₁	CE ₂	CE ₃	ZZ	ADSP	ADSC	ADV	WRITE	OE	CLK	DQ
Deselected Cycle, Power Down	None	H	X	X	L	X	L	X	X	X	L–H	Tri-State
Deselected Cycle, Power Down	None	L	L	X	L	L	X	X	X	X	L–H	Tri-State
Deselected Cycle, Power Down	None	L	X	H	L	L	X	X	X	X	L–H	Tri-State
Deselected Cycle, Power Down	None	L	L	X	L	H	L	X	X	X	L–H	Tri-State
Deselected Cycle, Power Down	None	X	X	H	L	H	L	X	X	X	L–H	Tri-State
Sleep Mode, Power Down	None	X	X	X	H	X	X	X	X	X	X	Tri-State
Read Cycle, Begin Burst	External	L	H	L	L	L	X	X	X	L	L–H	Q
Read Cycle, Begin Burst	External	L	H	L	L	L	X	X	X	H	L–H	Tri-State
Write Cycle, Begin Burst	External	L	H	L	L	H	L	X	L	X	L–H	D
Read Cycle, Begin Burst	External	L	H	L	L	H	L	X	H	L	L–H	Q
Read Cycle, Begin Burst	External	L	H	L	L	H	L	X	H	H	L–H	Tri-State
Read Cycle, Continue Burst	Next	X	X	X	L	H	H	L	H	L	L–H	Q
Read Cycle, Continue Burst	Next	X	X	X	L	H	H	L	H	H	L–H	Tri-State
Read Cycle, Continue Burst	Next	H	X	X	L	X	H	L	H	L	L–H	Q
Read Cycle, Continue Burst	Next	H	X	X	L	X	H	L	H	H	L–H	Tri-State
Write Cycle, Continue Burst	Next	X	X	X	L	H	H	L	L	X	L–H	D
Write Cycle, Continue Burst	Next	H	X	X	L	X	H	L	L	X	L–H	D
Read Cycle, Suspend Burst	Current	X	X	X	L	H	H	H	H	L	L–H	Q
Read Cycle, Suspend Burst	Current	X	X	X	L	H	H	H	H	H	L–H	Tri-State
Read Cycle, Suspend Burst	Current	H	X	X	L	X	H	H	H	L	L–H	Q
Read Cycle, Suspend Burst	Current	H	X	X	L	X	H	H	H	H	L–H	Tri-State
Write Cycle, Suspend Burst	Current	X	X	X	L	H	H	H	L	X	L–H	D
Write Cycle, Suspend Burst	Current	H	X	X	L	X	H	H	L	X	L–H	D

Notes

- X = Do Not Care, H = Logic HIGH, L = Logic LOW.
- WRITE = L when any one or more byte write enable signals and $\overline{BWE} = L$ or $\overline{GW} = L$. WRITE = H when all byte write enable signals, \overline{BWE} , $\overline{GW} = H$.
- The DQ pins are controlled by the current cycle and the OE signal. OE is asynchronous and is not sampled with the clock.
- The SRAM always initiates a read cycle when ADSP is asserted, regardless of the state of GW, BWE, or \overline{BW}_x . Writes may occur only on subsequent clocks after the ADSP or with the assertion of ADSC. As a result, OE must be driven HIGH prior to the start of the write cycle to enable the outputs to tri-state. OE is a do not care for the remainder of the write cycle.
- OE is asynchronous and is not sampled with the clock rise. It is masked internally during write cycles. During a read cycle all data bits are tri-state when \overline{OE} is inactive or when the device is deselected, and all data bits behave as outputs when OE is active (LOW).

Truth Table for Read/Write

The read-write truth table for CY7C1481BV33 follows. [7, 8]

Function (CY7C1481BV33)	GW	BWE	BW _D	BW _C	BW _B	BW _A
Read	H	H	X	X	X	X
Read	H	L	H	H	H	H
Write Byte A (DQ _A , DQP _A)	H	L	H	H	H	L
Write Byte B (DQ _B , DQP _B)	H	L	H	H	L	H
Write Bytes A, B (DQ _A , DQ _B , DQP _A , DQP _B)	H	L	H	H	L	L
Write Byte C (DQ _C , DQP _C)	H	L	H	L	H	H
Write Bytes C, A (DQ _C , DQ _A , DQP _C , DQP _A)	H	L	H	L	H	L
Write Bytes C, B (DQ _C , DQ _B , DQP _C , DQP _B)	H	L	H	L	L	H
Write Bytes C, B, A (DQ _C , DQ _B , DQ _A , DQP _C , DQP _B , DQP _A)	H	L	H	L	L	L
Write Byte D (DQ _D , DQP _D)	H	L	L	H	H	H
Write Bytes D, A (DQ _D , DQ _A , DQP _D , DQP _A)	H	L	L	H	H	L
Write Bytes D, B (DQ _D , DQ _B , DQP _D , DQP _B)	H	L	L	H	L	H
Write Bytes D, B, A (DQ _D , DQ _B , DQ _A , DQP _D , DQP _B , DQP _A)	H	L	L	H	L	L
Write Bytes D, B (DQ _D , DQ _B , DQP _D , DQP _B)	H	L	L	L	H	H
Write Bytes D, B, A (DQ _D , DQ _C , DQ _A , DQP _D , DQP _C , DQP _A)	H	L	L	L	H	L
Write Bytes D, C, A (DQ _D , DQ _B , DQ _A , DQP _D , DQP _B , DQP _A)	H	L	L	L	L	H
Write All Bytes	H	L	L	L	L	L
Write All Bytes	L	X	X	X	X	X

Notes

7. X = Do Not Care, H = Logic HIGH, L = Logic LOW.

8. Table only includes a partial listing of the byte write combinations. Any combination of BW_x is valid. An appropriate write is performed based on which byte write is active.

IEEE 1149.1 Serial Boundary Scan (JTAG)

The CY7C1481BV33 incorporates a serial boundary scan test access port (TAP). This port operates in accordance with IEEE Standard 1149.1-1990 but does not have the set of functions required for full 1149.1 compliance. These functions from the IEEE specification are excluded because their inclusion places an added delay in the critical speed path of the SRAM. Note that the TAP controller functions in a manner that does not conflict with the operation of other devices using 1149.1 fully compliant TAPs. The TAP operates using JEDEC standard 3.3 V or 2.5 V I/O logic levels.

The CY7C1481BV33 contains a TAP controller, instruction register, boundary scan register, bypass register, and ID register.

Disabling the JTAG Feature

It is possible to operate the SRAM without using the JTAG feature. To disable the TAP controller, tie TCK LOW (V_{SS}) to prevent device clocking. TDI and TMS are internally pulled up and may be unconnected. They may alternatively be connected to V_{DD} through a pull up resistor. TDO must be left unconnected. At power up, the device comes up in a reset state, which does not interfere with the operation of the device.

Test Access Port (TAP)

Test Clock (TCK)

The test clock is used only with the TAP controller. All inputs are captured on the rising edge of TCK. All outputs are driven from the falling edge of TCK.

Test Mode Select (TMS)

The TMS input gives commands to the TAP controller and is sampled on the rising edge of TCK. You can leave this ball unconnected if the TAP is not used. The ball is pulled up internally, resulting in a logic HIGH level.

Test Data-In (TDI)

The TDI ball serially inputs information into the registers and can be connected to the input of any of the registers. The register between TDI and TDO is chosen by the instruction that is loaded into the TAP instruction register. For information on loading the instruction register, see the [TAP Controller State Diagram on page 13](#). TDI is internally pulled up and can be unconnected if the TAP is unused in an application. TDI is connected to the most significant bit (MSB) of any register.

Test Data-Out (TDO)

The TDO output ball serially clocks data-out from the registers. Whether the output is active depends on the current state of the TAP state machine (see [Identification Codes on page 17](#)). The output changes on the falling edge of TCK. TDO is connected to the least significant bit (LSB) of any register.

Performing a TAP Reset

To perform a RESET, force TMS HIGH (V_{DD}) for five rising edges of TCK. This RESET does not affect the operation of the SRAM and may be performed while the SRAM is operating.

At power up, the TAP is reset internally to ensure that TDO comes up in a High Z state.

TAP Registers

Registers are connected between the TDI and TDO balls to scan the data in and out of the SRAM test circuitry. Only one register can be selected at a time through the instruction register. Data is serially loaded into the TDI ball on the rising edge of TCK. Data is output on the TDO ball on the falling edge of TCK.

Instruction Register

Three-bit instructions can be serially loaded into the instruction register. This register is loaded when it is placed between the TDI and TDO balls, as shown in the [TAP Controller Block Diagram on page 14](#). At power up, the instruction register is loaded with the IDCODE instruction. It is also loaded with the IDCODE instruction if the controller is placed in a reset state, as described in the previous section.

When the TAP controller is in the Capture-IR state, the two least significant bits are loaded with a binary "01" pattern to enable fault isolation of the board level serial test data path.

Bypass Register

To save time when serially shifting data through registers, it is sometimes advantageous to skip certain chips. The bypass register is a single-bit register that is placed between the TDI and TDO balls. This shifts the data through the SRAM with minimal delay. The bypass register is set LOW (V_{SS}) when the BYPASS instruction is executed.

Boundary Scan Register

The boundary scan register is connected to all the input and bidirectional balls on the SRAM. The $\times 36$ configuration has a 73-bit long register.

The boundary scan register is loaded with the contents of the RAM IO ring when the TAP controller is in the Capture-DR state and is then placed between the TDI and TDO balls when the controller is moved to the Shift-DR state. The EXTEST, SAMPLE/PRELOAD and SAMPLE Z instructions are used to capture the contents of the I/O ring.

The [Boundary Scan Exit Order on page 18](#) show the order in which the bits are connected. Each bit corresponds to one of the bumps on the SRAM package. The MSB of the register is connected to TDI and the LSB is connected to TDO.

Identification (ID) Register

The ID register is loaded with a vendor specific, 32-bit code during the Capture-DR state when the IDCODE command is loaded in the instruction register. The IDCODE is hardwired into the SRAM and can be shifted out when the TAP controller is in the Shift-DR state. The ID register has a vendor code and other information described in [Identification Register Definitions on page 17](#).

TAP Instruction Set

Overview

Eight different instructions are possible with the three-bit instruction register. All combinations are listed in [Identification Codes on page 17](#). Three of these instructions are listed as RESERVED and must not be used. The other five instructions are described in this section in detail.

The TAP controller used in this SRAM is not fully compliant to the 1149.1 convention because some of the mandatory 1149.1 instructions are not fully implemented.

The TAP controller cannot be used to load address data or control signals into the SRAM and cannot preload the I/O buffers. The SRAM does not implement the 1149.1 commands EXTEST or INTEST or the PRELOAD portion of SAMPLE/PRELOAD; rather, it performs a capture of the I/O ring when these instructions are executed.

Instructions are loaded into the TAP controller during the Shift-IR state when the instruction register is placed between TDI and TDO. During this state, instructions are shifted through the instruction register through the TDI and TDO balls. To execute the instruction after it is shifted in, the TAP controller must be moved into the Update-IR state.

EXTEST

EXTEST is a mandatory 1149.1 instruction that is executed whenever the instruction register is loaded with all zeros. EXTEST is not implemented in this SRAM TAP controller, and therefore this device is not compliant to 1149.1. The TAP controller does not recognize an all-zero instruction.

When an EXTEST instruction is loaded into the instruction register, the SRAM responds as if a SAMPLE/PRELOAD instruction is loaded. There is one difference between the two instructions. Unlike the SAMPLE/PRELOAD instruction, EXTEST places the SRAM outputs in a High Z state.

IDCODE

The IDCODE instruction loads a vendor specific, 32-bit code into the instruction register. It also places the instruction register between the TDI and TDO balls and shifts the IDCODE out of the device when the TAP controller enters the Shift-DR state.

The IDCODE instruction is loaded into the instruction register at power up or whenever the TAP controller is in a test logic reset state.

SAMPLE Z

The SAMPLE Z instruction connects the boundary scan register between the TDI and TDO balls when the TAP controller is in a Shift-DR state. It also places all SRAM outputs into a High Z state.

SAMPLE/PRELOAD

SAMPLE/PRELOAD is a 1149.1 mandatory instruction. The PRELOAD portion of this instruction is not implemented, so the device TAP controller is not fully 1149.1 compliant.

When the SAMPLE/PRELOAD instruction is loaded into the instruction register and the TAP controller is in the Capture-DR state, a snapshot of data on the inputs and bidirectional balls is captured in the boundary scan register.

Be aware that the TAP controller clock only operates at a frequency up to 10 MHz, while the SRAM clock operates more than an order of magnitude faster. Because there is a large difference in the clock frequencies, it is possible that during the Capture-DR state, an input or output may undergo a transition. The TAP may then try to capture a signal while in transition (metastable state). This does not harm the device, but there is no guarantee as to the value that may be captured. Repeatable results may not be possible.

To guarantee that the boundary scan register captures the correct value of a signal, the SRAM signal must be stabilized long enough to meet the TAP controller's capture setup plus hold time (t_{CS} plus t_{CH}).

The SRAM clock input might not be captured correctly if there is no way in a design to stop (or slow) the clock during a SAMPLE/PRELOAD instruction. If this is an issue, it is still possible to capture all other signals and simply ignore the value of the CLK captured in the boundary scan register.

After the data is captured, it is possible to shift out the data by putting the TAP into the Shift-DR state. This places the boundary scan register between the TDI and TDO balls.

Note that because the PRELOAD part of the command is not implemented, putting the TAP to the Update-DR state while performing a SAMPLE/PRELOAD instruction has the same effect as the Pause-DR command.

BYPASS

When the BYPASS instruction is loaded in the instruction register and the TAP is placed in a Shift-DR state, the bypass register is placed between the TDI and TDO balls. The advantage of the BYPASS instruction is that it shortens the boundary scan path when multiple devices are connected together on a board.

Reserved

These instructions are not implemented but are reserved for future use. Do not use these instructions.

TAP Controller State Diagram

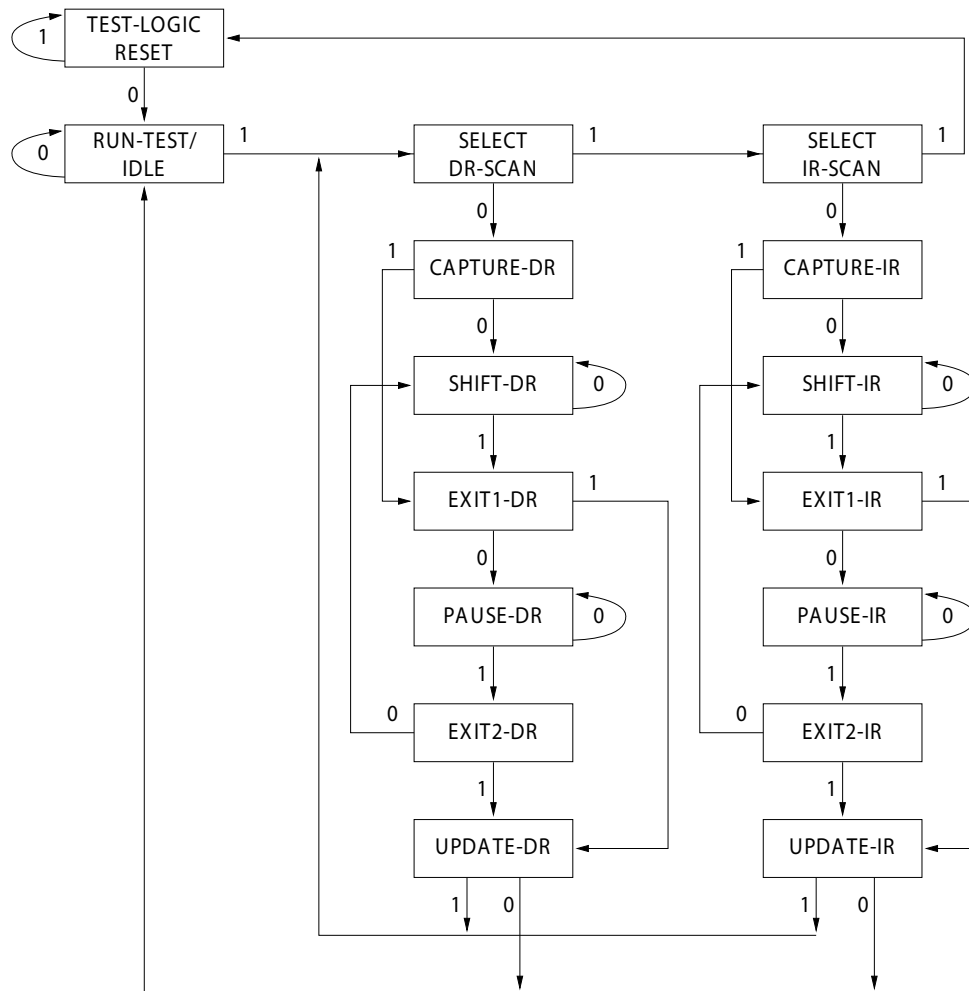

The 0/1 next to each state represents the value of TMS at the rising edge of TCK.

TAP Controller Block Diagram

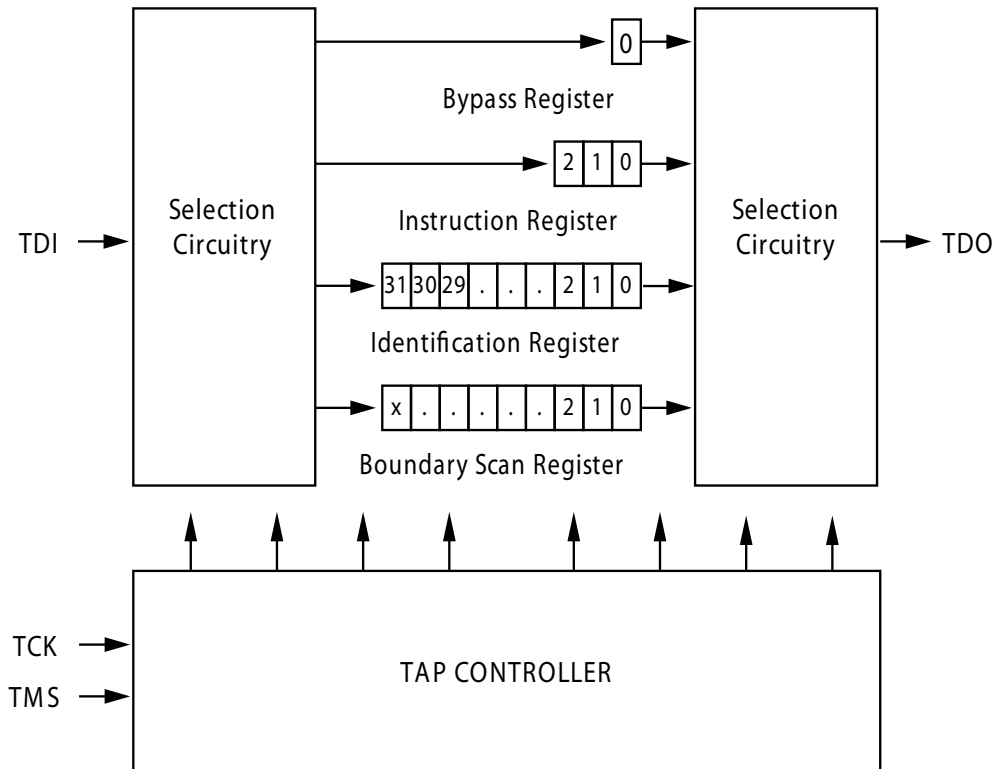

TAP Timing

Figure 3 shows the TAP timing diagram.

Figure 3. TAP Timing

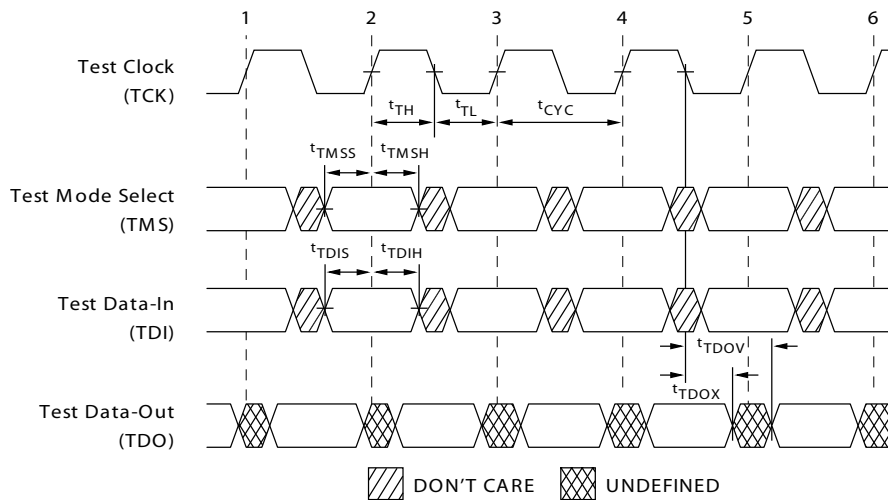

TAP AC Switching Characteristics

Over the Operating Range

Parameter ^[9, 10]	Description	Min	Max	Unit
Clock				
t_{TCYC}	TCK Clock Cycle Time	50	–	ns
t_{TF}	TCK Clock Frequency	–	20	MHz
t_{TH}	TCK Clock HIGH Time	20	–	ns
t_{TL}	TCK Clock LOW Time	20	–	ns
Output Times				
t_{TDOV}	TCK Clock LOW to TDO Valid	–	10	ns
t_{TDOX}	TCK Clock LOW to TDO Invalid	0	–	ns
Setup Times				
t_{TMSS}	TMS Setup to TCK Clock Rise	5	–	ns
t_{TDIS}	TDI Setup to TCK Clock Rise	5	–	ns
t_{CS}	Capture Setup to TCK Rise	5	–	ns
Hold Times				
t_{TMSH}	TMS hold after TCK Clock Rise	5	–	ns
t_{TDIH}	TDI Hold after Clock Rise	5	–	ns
t_{CH}	Capture Hold after Clock Rise	5	–	ns

Notes

- 9. t_{CS} and t_{CH} refer to the setup and hold time requirements of latching data from the boundary scan register.
- 10. Test conditions are specified using the load in TAP AC test Conditions. $t_R/t_F = 1$ ns.

3.3 V TAP AC Test Conditions

Input pulse levels V_{SS} to 3.3 V
 Input rise and fall times 1 ns
 Input timing reference levels 1.5 V
 Output reference levels 1.5 V
 Test load termination supply voltage 1.5 V

2.5 V TAP AC Test Conditions

Input pulse levels V_{SS} to 2.5 V
 Input rise and fall time 1 ns
 Input timing reference levels 1.25 V
 Output reference levels 1.25 V
 Test load termination supply voltage 1.25 V

3.3 V TAP AC Output Load Equivalent

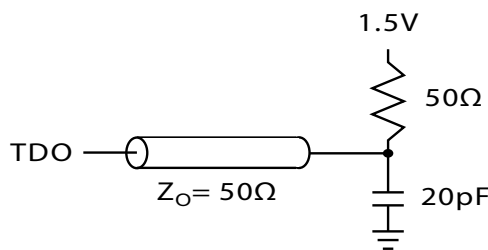

2.5 V TAP AC Output Load Equivalent

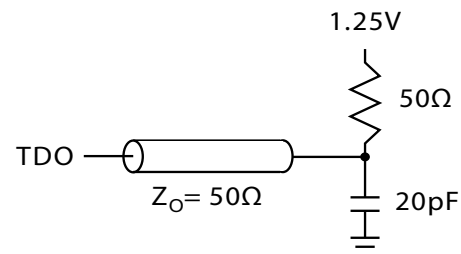

TAP DC Electrical Characteristics and Operating Conditions

(0 °C < T_A < +70 °C; V_{DD} = 3.135 V to 3.6 V unless otherwise noted)

Parameter ^[11]	Description	Conditions	Min	Max	Unit	
V _{OH1}	Output HIGH Voltage	I _{OH} = -4.0 mA	V _{DDQ} = 3.3 V	2.4	-	V
		I _{OH} = -1.0 mA	V _{DDQ} = 2.5 V	2.0	-	V
V _{OH2}	Output HIGH Voltage	I _{OH} = -100 μA	V _{DDQ} = 3.3 V	2.9	-	V
			V _{DDQ} = 2.5 V	2.1	-	V
V _{OL1}	Output LOW Voltage	I _{OL} = 8.0 mA	V _{DDQ} = 3.3 V	-	0.4	V
			V _{DDQ} = 2.5 V	-	0.4	V
V _{OL2}	Output LOW Voltage	I _{OL} = 100 μA	V _{DDQ} = 3.3 V	-	0.2	V
			V _{DDQ} = 2.5 V	-	0.2	V
V _{IH}	Input HIGH Voltage		V _{DDQ} = 3.3 V	2.0	V _{DD} + 0.3	V
			V _{DDQ} = 2.5 V	1.7	V _{DD} + 0.3	V
V _{IL}	Input LOW Voltage		V _{DDQ} = 3.3 V	-0.3	0.8	V
			V _{DDQ} = 2.5 V	-0.3	0.7	V
I _X	Input Load Current	GND ≤ V _{IN} ≤ V _{DDQ}	-5	5	μA	

Note

11. All voltages refer to V_{SS} (GND).

Identification Register Definitions

Bit# 24 is “1” in the ID Register definitions for both 2.5 V and 3.3 V versions of the device.

Instruction Field	CY7C1481BV33 (2M × 36)	Description
Revision Number (31:29)	000	Describes the version number
Device Depth (28:24)	01011	Reserved for internal use
Architecture/Memory Type (23:18)	000001	Defines memory type and architecture
Bus Width/Density (17:12)	100100	Defines width and density
Cypress JEDEC ID Code (11:1)	00000110100	Enables unique identification of SRAM vendor
ID Register Presence Indicator (0)	1	Indicates the presence of an ID register

Scan Register Sizes

Register Name	Bit Size (× 36)
Instruction Bypass	3
Bypass	1
ID	32
Boundary Scan Order – 165-ball FBGA	73

Identification Codes

Instruction	Code	Description
EXTEST	000	Captures I/O ring contents.
IDCODE	001	Loads the ID register with the vendor ID code and places the register between TDI and TDO. This operation does not affect SRAM operations.
SAMPLE Z	010	Captures I/O ring contents. Places the boundary scan register between TDI and TDO. Forces all SRAM output drivers to a High Z state.
RESERVED	011	Do Not Use: This instruction is reserved for future use.
SAMPLE/PRELOAD	100	Captures I/O ring contents. Places the boundary scan register between TDI and TDO. Does not affect SRAM operation.
RESERVED	101	Do Not Use: This instruction is reserved for future use.
RESERVED	110	Do Not Use: This instruction is reserved for future use.
BYPASS	111	Places the bypass register between TDI and TDO. This operation does not affect SRAM operations.

Boundary Scan Exit Order

(2M × 36)

Bit #	165-ball ID
1	C1
2	D1
3	E1
4	D2
5	E2
6	F1
7	G1
8	F2
9	G2
10	J1
11	K1
12	L1
13	J2
14	M1
15	N1
16	K2
17	L2
18	M2
19	R1
20	R2

Bit #	165-ball ID
21	R3
22	P2
23	R4
24	P6
25	R6
26	N6
27	P11
28	R8
29	P3
30	P4
31	P8
32	P9
33	P10
34	R9
35	R10
36	R11
37	N11
38	M11
39	L11
40	M10

Bit #	165-ball ID
41	L10
42	K11
43	J11
44	K10
45	J10
46	H11
47	G11
48	F11
49	E11
50	D10
51	D11
52	C11
53	G10
54	F10
55	E10
56	A10
57	B10
58	A9
59	B9
60	A8

Bit #	165-ball ID
61	B8
62	A7
63	B7
64	B6
65	A6
66	B5
67	A5
68	A4
69	B4
70	B3
71	A3
72	A2
73	B2

Maximum Ratings

Exceeding the maximum ratings may impair the useful life of the device. These user guidelines are not tested.

Storage Temperature	-65 °C to +150 °C
Ambient Temperature with Power Applied	-55 °C to +125 °C
Supply Voltage on V _{DD} Relative to GND	-0.3 V to +4.6 V
Supply Voltage on V _{DDQ} Relative to GND	-0.3 V to +V _{DD}
DC Voltage Applied to Outputs in Tri-State	-0.5 V to V _{DDQ} + 0.5 V

DC Input Voltage	-0.5 V to V _{DD} + 0.5 V
Current into Outputs (LOW)	20 mA
Static Discharge Voltage (MIL-STD-883, Method 3015)	>2001 V
Latch Up Current	>200 mA

Operating Range

Range	Ambient Temperature	V _{DD}	V _{DDQ}
Commercial	0 °C to +70 °C	3.3 V – 5% / + 10%	2.5 V – 5% to V _{DD}
Industrial	-40 °C to +85 °C		

Electrical Characteristics

Over the Operating Range

Parameter ^[12, 13]	Description	Test Conditions	Min	Max	Unit	
V _{DD}	Power Supply Voltage		3.135	3.6	V	
V _{DDQ}	IO Supply Voltage	For 3.3 V I/O	3.135	V _{DD}	V	
		For 2.5 V I/O	2.375	2.625	V	
V _{OH}	Output HIGH Voltage	For 3.3 V I/O, I _{OH} = -4.0 mA	2.4	-	V	
		For 2.5 V I/O, I _{OH} = -1.0 mA	2.0	-	V	
V _{OL}	Output LOW Voltage	For 3.3 V I/O, I _{OL} = 8.0 mA	-	0.4	V	
		For 2.5 V I/O, I _{OL} = 1.0 mA	-	0.4	V	
V _{IH}	Input HIGH Voltage ^[12]	For 3.3 V I/O	2.0	V _{DD} + 0.3 V	V	
		For 2.5 V I/O	1.7	V _{DD} + 0.3 V	V	
V _{IL}	Input LOW Voltage ^[12]	For 3.3 V I/O	-0.3	0.8	V	
		For 2.5 V I/O	-0.3	0.7	V	
I _X	Input Leakage Current Except ZZ and MODE	GND ≤ V _I ≤ V _{DDQ}	-5	5	μA	
	Input Current of MODE	Input = V _{SS}	-30	-	μA	
		Input = V _{DD}	-	5	μA	
	Input Current of ZZ	Input = V _{SS}	-5	-	μA	
Input = V _{DD}		-	30	μA		
I _{OZ}	Output Leakage Current	GND ≤ V _I ≤ V _{DD} , Output Disabled	-5	5	μA	
I _{DD} ^[14]	V _{DD} Operating Supply Current	V _{DD} = Max, I _{OUT} = 0 mA, f = f _{MAX} = 1/t _{CYC}	7.5 ns cycle, 133 MHz	-	335	mA
I _{SB1}	Automatic CE Power Down Current – TTL Inputs	Max V _{DD} , Device Deselected, V _{IN} ≥ V _{IH} or V _{IN} ≤ V _{IL} , f = f _{MAX} , inputs switching	7.5 ns cycle, 133 MHz	-	200	mA
I _{SB2}	Automatic CE Power Down Current – CMOS Inputs	Max V _{DD} , Device Deselected, V _{IN} ≥ V _{DD} - 0.3 V or V _{IN} ≤ 0.3 V, f = 0, inputs static	7.5 ns cycle, 133 MHz	-	150	mA
I _{SB3}	Automatic CE Power Down Current – CMOS Inputs	Max V _{DD} , Device Deselected, V _{IN} ≥ V _{DDQ} - 0.3 V or V _{IN} ≤ 0.3 V, f = f _{MAX} , inputs switching	7.5 ns cycle, 133 MHz	-	200	mA
I _{SB4}	Automatic CE Power Down Current – TTL Inputs	Max V _{DD} , Device Deselected, V _{IN} ≥ V _{DD} - 0.3 V or V _{IN} ≤ 0.3 V, f = 0, inputs static	7.5 ns cycle, 133 MHz	-	165	mA

Notes

12. Overshoot: V_{IH(AC)} < V_{DD} + 1.5 V (pulse width less than t_{CYC}/2). Undershoot: V_{IL(AC)} > -2 V (pulse width less than t_{CYC}/2).
13. T_{Power-up}: assumes a linear ramp from 0 V to V_{DD(minimum)} within 200 ms. During this time V_{IH} < V_{DD} and V_{DDQ} ≤ V_{DD}.
14. The operation current is calculated with 50% read cycle and 50% write cycle.

Capacitance

Parameter ^[15]	Description	Test Conditions	100-pin TQFP Max	165-ball FBGA Max	Unit
C _{ADDRESS}	Address Input Capacitance	T _A = 25 °C, f = 1 MHz, V _{DD} = 3.3 V, V _{DDQ} = 2.5 V	6	6	pF
C _{DATA}	Data Input Capacitance		5	5	pF
C _{CTRL}	Control Input Capacitance		8	8	pF
C _{CLK}	Clock Input Capacitance		6	6	pF
C _{IO}	Input/Output Capacitance		5	5	pF

Thermal Resistance

Parameter ^[15]	Description	Test Conditions	100-pin TQFP Package	165-ball FBGA Package	Unit
Θ _{JA}	Thermal Resistance (Junction to Ambient)	Test conditions follow standard test methods and procedures for measuring thermal impedance, per EIA/JESD51.	24.63	16.3	°C/W
Θ _{JC}	Thermal Resistance (Junction to Case)		2.28	2.1	°C/W

AC Test Loads and Waveforms

Figure 4. AC Test Loads and Waveforms

3.3V IO Test Load

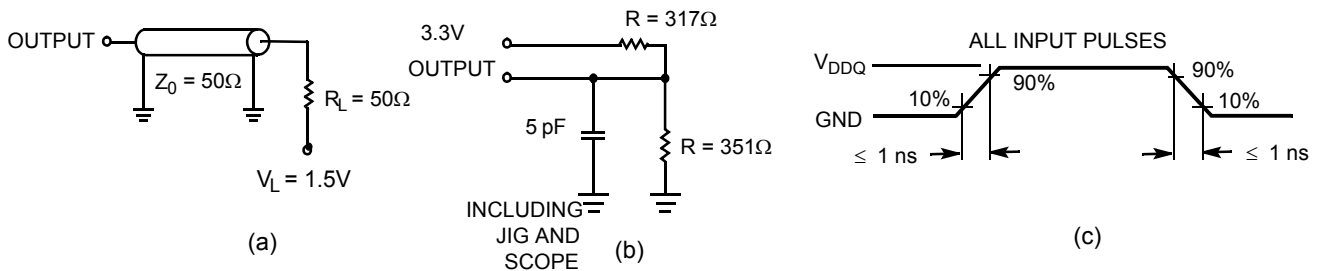

2.5V IO Test Load

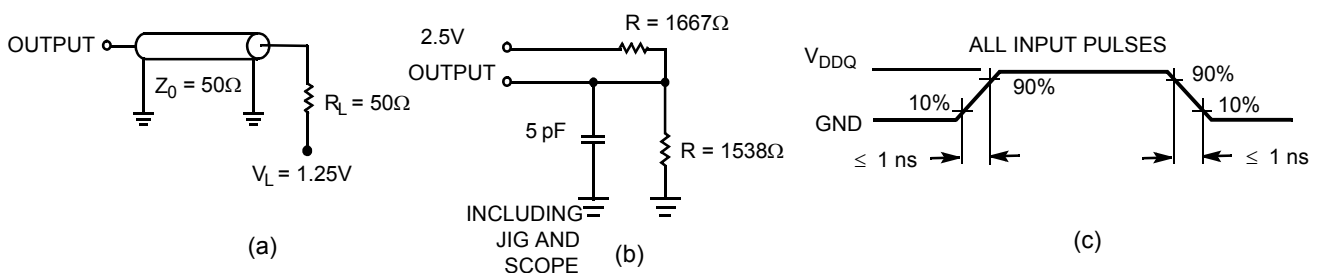

Note

15. Tested initially and after any design or process change that may affect these parameters.

Switching Characteristics

Over the Operating Range

Parameter ^[16, 17]	Description	133 MHz		Unit
		Min	Max	
t _{POWER}	V _{DD} (typical) to the First Access ^[18]	1	–	ms
Clock				
t _{CYC}	Clock Cycle Time	7.5	–	ns
t _{CH}	Clock HIGH	2.5	–	ns
t _{CL}	Clock LOW	2.5	–	ns
Output Times				
t _{CDV}	Data Output Valid After CLK Rise	–	6.5	ns
t _{DOH}	Data Output Hold After CLK Rise	2.5	–	ns
t _{CLZ}	Clock to Low Z ^[19, 20, 21]	3.0	–	ns
t _{CHZ}	Clock to High Z ^[19, 20, 21]	–	3.8	ns
t _{OE_V}	$\overline{\text{OE}}$ LOW to Output Valid	–	3.0	ns
t _{OE_{LZ}}	$\overline{\text{OE}}$ LOW to Output Low Z ^[19, 20, 21]	0	–	ns
t _{OE_{HZ}}	$\overline{\text{OE}}$ HIGH to Output High Z ^[19, 20, 21]	–	3.0	ns
Setup Times				
t _{AS}	Address Setup Before CLK Rise	1.5	–	ns
t _{ADS}	ADSP, ADSC Setup Before CLK Rise	1.5	–	ns
t _{ADVS}	$\overline{\text{ADV}}$ Setup Before CLK Rise	1.5	–	ns
t _{WES}	$\overline{\text{GW}}$, $\overline{\text{BWE}}$, $\overline{\text{BW}}_x$ Setup Before CLK Rise	1.5	–	ns
t _{DS}	Data Input Setup Before CLK Rise	1.5	–	ns
t _{CES}	Chip Enable Setup	1.5	–	ns
Hold Times				
t _{AH}	Address Hold After CLK Rise	0.5	–	ns
t _{ADH}	ADSP, ADSC Hold After CLK Rise	0.5	–	ns
t _{WEH}	$\overline{\text{GW}}$, $\overline{\text{BWE}}$, $\overline{\text{BW}}_x$ Hold After CLK Rise	0.5	–	ns
t _{ADVH}	$\overline{\text{ADV}}$ Hold After CLK Rise	0.5	–	ns
t _{DH}	Data Input Hold After CLK Rise	0.5	–	ns
t _{CEH}	Chip Enable Hold After CLK Rise	0.5	–	ns

Notes

16. Timing reference level is 1.5 V when V_{DDQ} = 3.3 V and is 1.25 V when V_{DDQ} = 2.5 V.

17. Test conditions shown in (a) of [Figure 4 on page 20](#) unless otherwise noted.

18. This part has an internal voltage regulator; t_{POWER} is the time that the power is supplied above V_{DD(minimum)} initially, before a read or write operation can be initiated.

19. t_{CHZ}, t_{CLZ}, t_{OE_{LZ}}, and t_{OE_{HZ}} are specified with AC test conditions shown in part (b) of [Figure 4 on page 20](#). Transition is measured ±200 mV from steady-state voltage.

20. At any supplied voltage and temperature, t_{OE_{HZ}} is less than t_{OE_{LZ}} and t_{CHZ} is less than t_{CLZ} to eliminate bus contention between SRAMs when sharing the same data bus. These specifications do not imply a bus contention condition, but reflect parameters guaranteed over worst case user conditions. The device is designed to achieve High Z before Low Z under the same system conditions.

21. This parameter is sampled and not 100% tested.

Timing Diagrams

Figure 5. Read Cycle Timing [22]

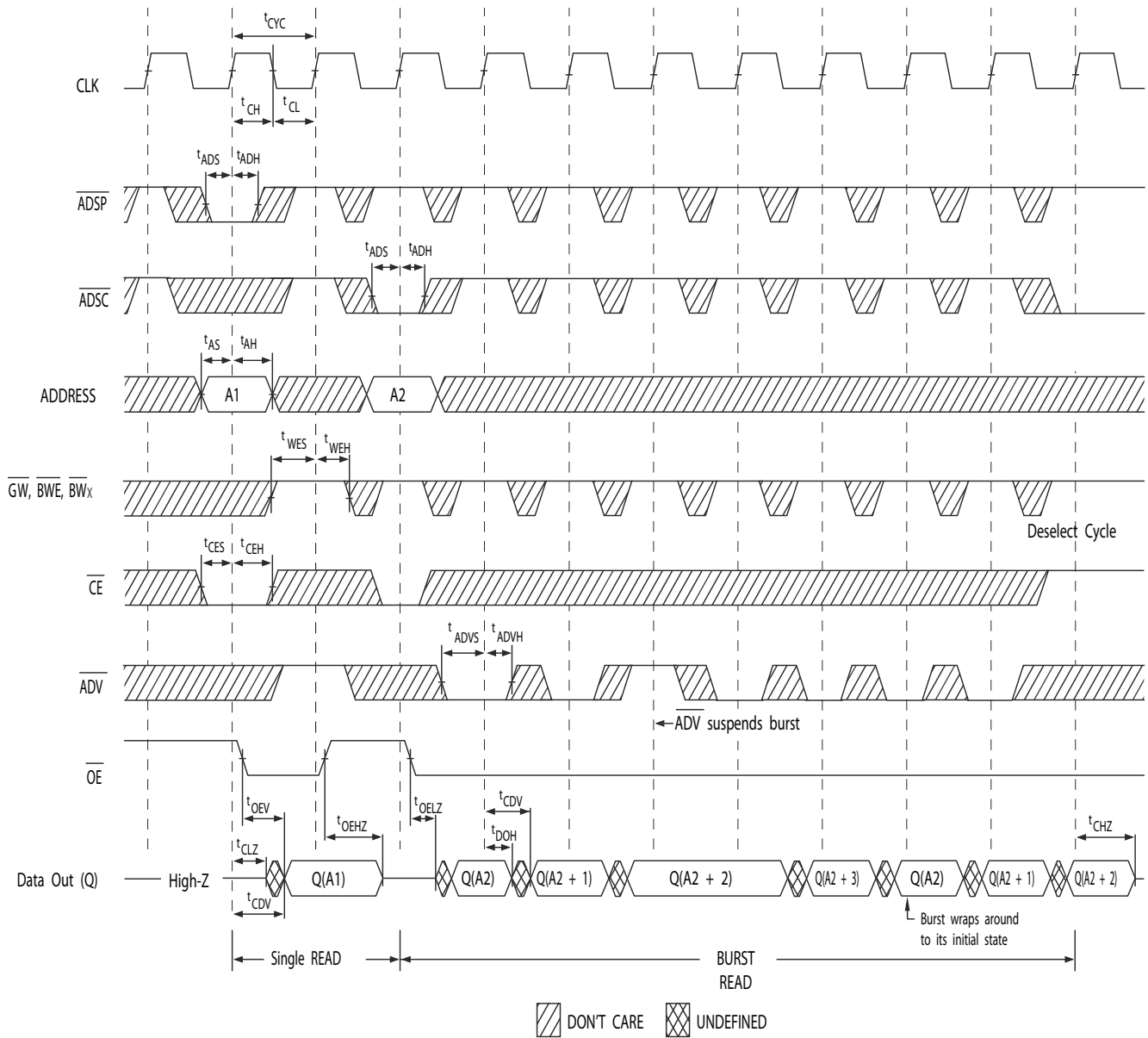

Note
 22. On this diagram, when \overline{CE} is LOW: \overline{CE}_1 is LOW, \overline{CE}_2 is HIGH, and \overline{CE}_3 is LOW. When \overline{CE} is HIGH: \overline{CE}_1 is HIGH, \overline{CE}_2 is LOW, or \overline{CE}_3 is HIGH.

Timing Diagrams (continued)

Figure 6. Write Cycle Timing [23, 24]

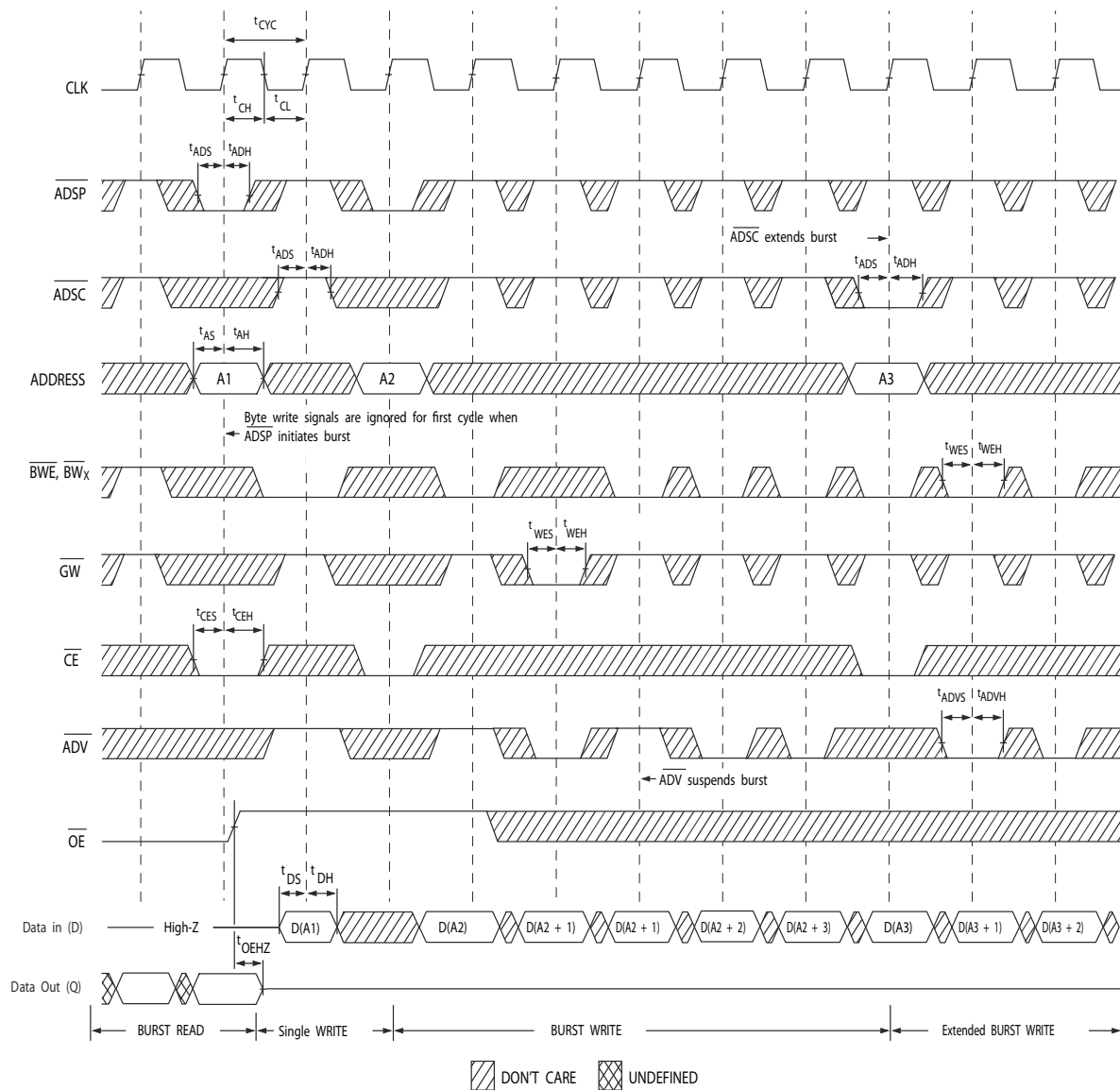

Notes

23. On this diagram, when \overline{CE}_1 is LOW: \overline{CE}_1 is LOW, CE_2 is HIGH, and \overline{CE}_3 is LOW. When \overline{CE}_1 is HIGH: \overline{CE}_1 is HIGH, CE_2 is LOW, or \overline{CE}_3 is HIGH.
 24. Full width write can be initiated by either GW LOW; or by GW HIGH, BWE LOW, and BW_x LOW.

Timing Diagrams (continued)

Figure 7. Read/Write Cycle Timing [25, 26, 27]

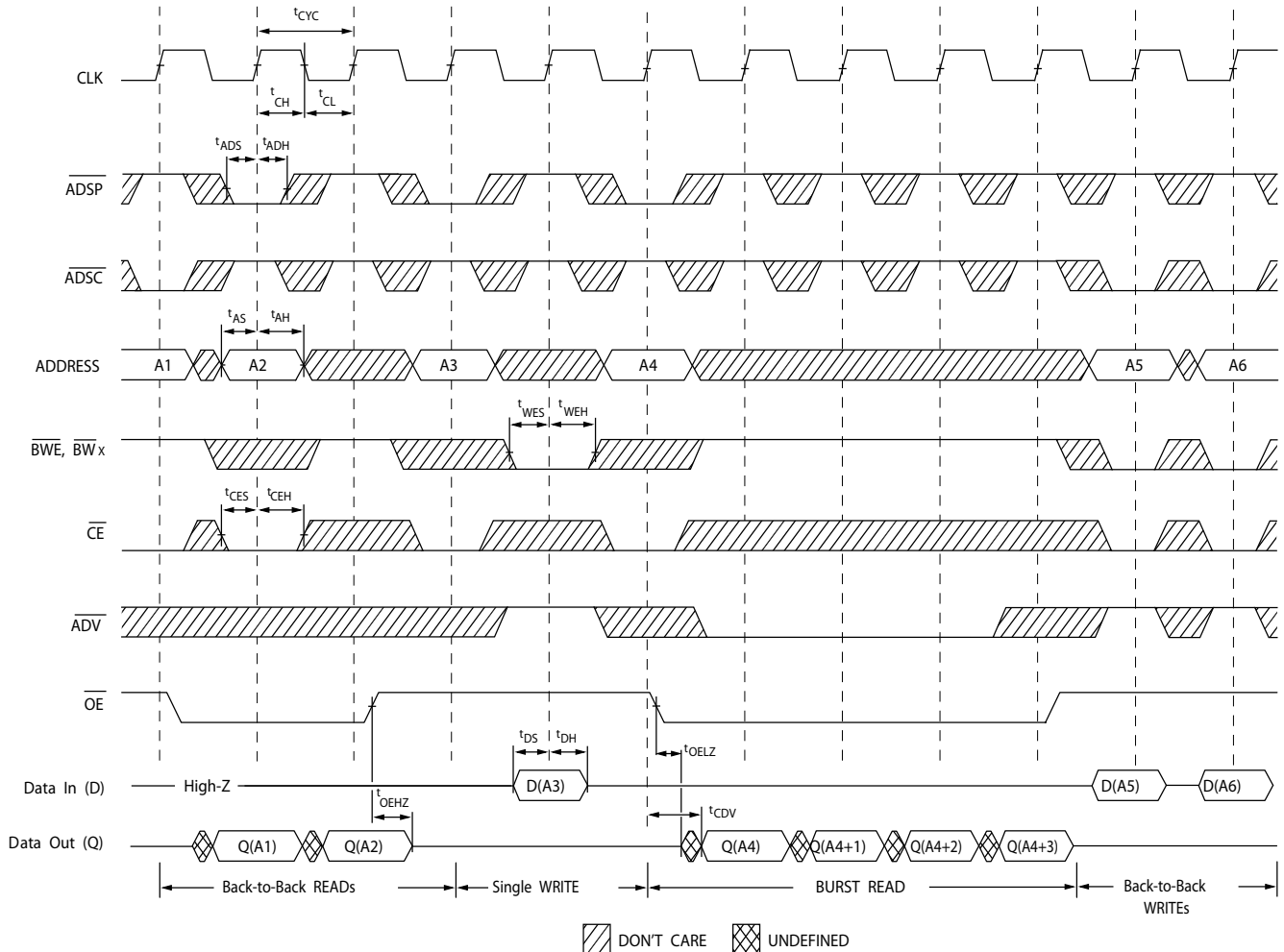

Notes

- 25. On this diagram, when \overline{CE} is LOW: \overline{CE}_1 is LOW, \overline{CE}_2 is HIGH, and \overline{CE}_3 is LOW. When \overline{CE} is HIGH: \overline{CE}_1 is HIGH, \overline{CE}_2 is LOW, or \overline{CE}_3 is HIGH.
- 26. The data bus (Q) remains in High Z following a write cycle, unless a new read access is initiated by ADSP or ADSC.
- 27. \overline{GW} is HIGH.

Timing Diagrams (continued)

Figure 8. ZZ Mode Timing [28, 29]

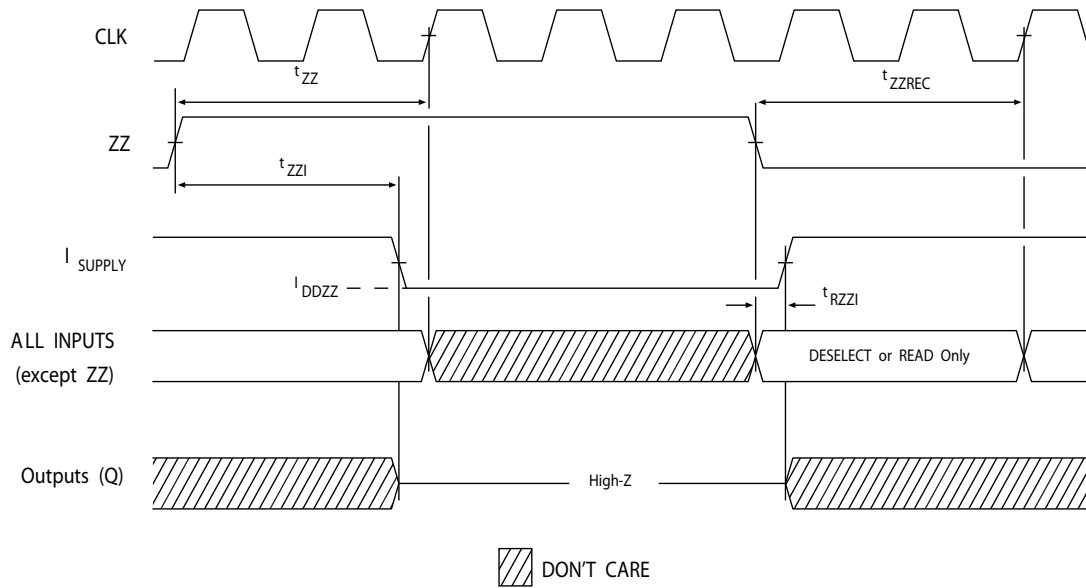

Notes

- 28. Device must be deselected when entering ZZ mode. See Truth Table on page 9 for all possible signal conditions to deselect the device.
- 29. DQs are in High Z when exiting ZZ sleep mode.

Ordering Information

Not all of the speed, package, and temperature ranges are available. Please contact your local sales representative or visit www.cypress.com for actual products offered.

Speed (MHz)	Ordering Code	Package Diagram	Part and Package Type	Operating Range
133	CY7C1481BV33-133AXI	51-85050	100-pin TQFP (14 × 20 × 1.4 mm) Pb-free	Industrial
	CY7C1481BV33-133BZI	51-85165	165-ball FBGA (15 × 17 × 1.4 mm)	
	CY7C1481BV33-133BZXC		165-ball FBGA (15 × 17 × 1.4 mm) Pb-free	Commercial

Ordering Code Definitions

CY 7 C 1481 B V33 - 133 XX X X

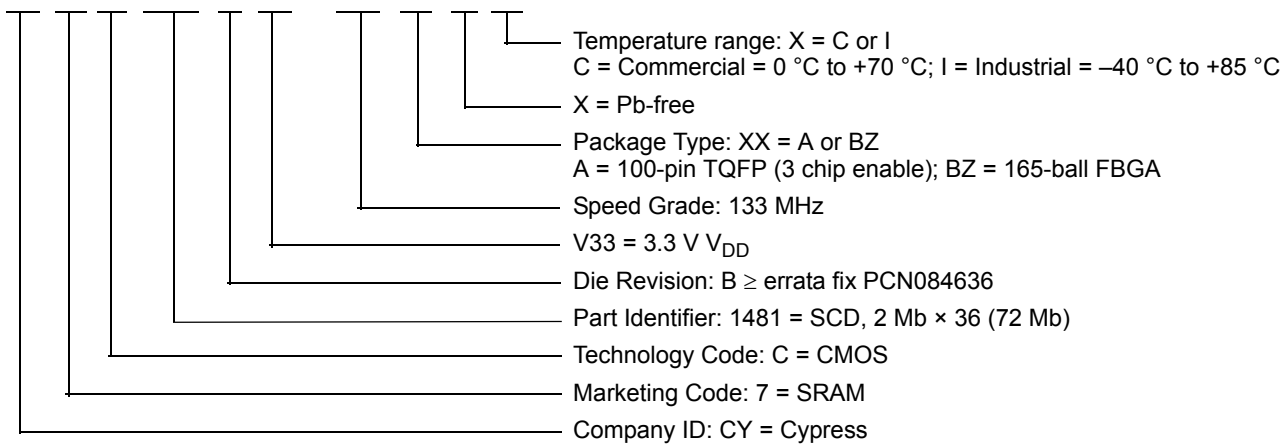

Package Diagrams

Figure 9. 100-pin TQFP (14 × 20 × 1.4 mm) A100RA Package Outline, 51-85050

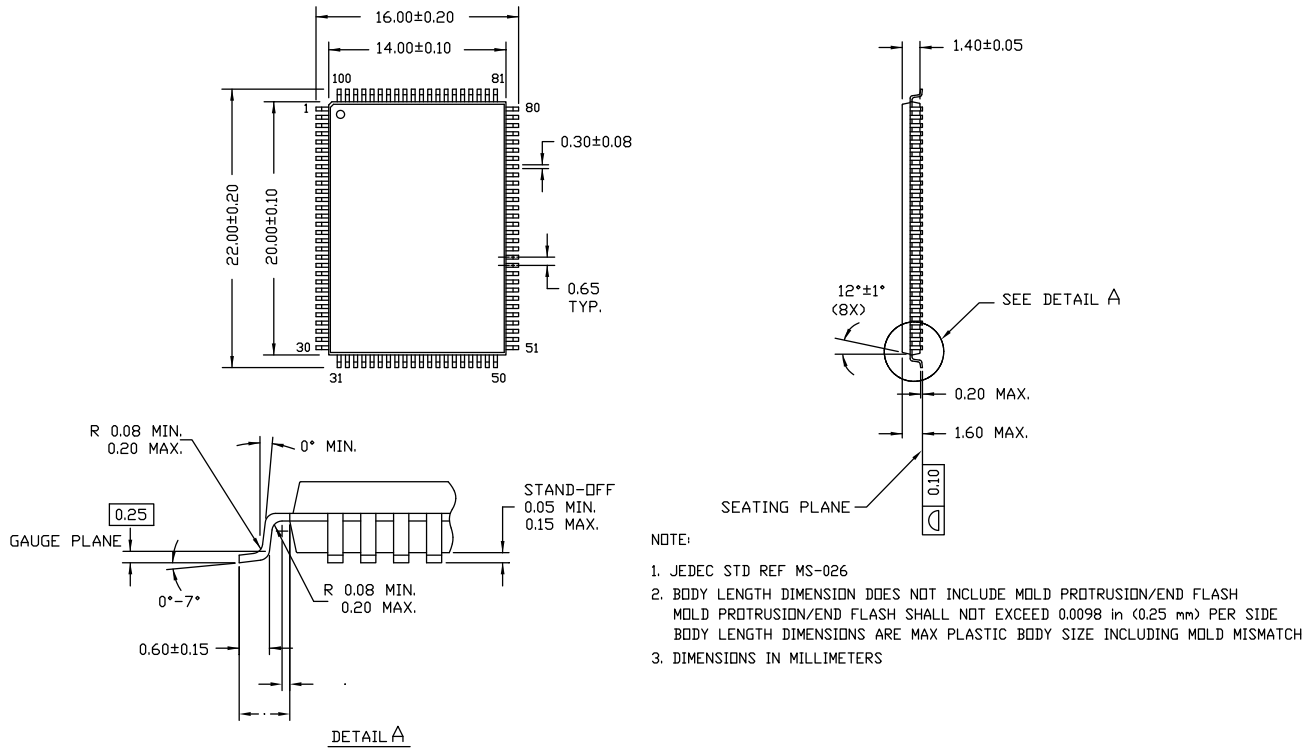

51-85050 *E

Package Diagrams (continued)

Figure 10. 165-ball FBGA (15 × 17 × 1.4 mm (0.45 Ball Diameter)) Package Outline, 51-85165

NOTES:
 SOLDER PAD TYPE: SOLDER MASK DEFINED (SMD)
 PACKAGE WEIGHT: 0.60g
 JEDEC REFERENCE: MO-216 / ISSUE E
 PACKAGE CODES: BB0AA / BW0AG

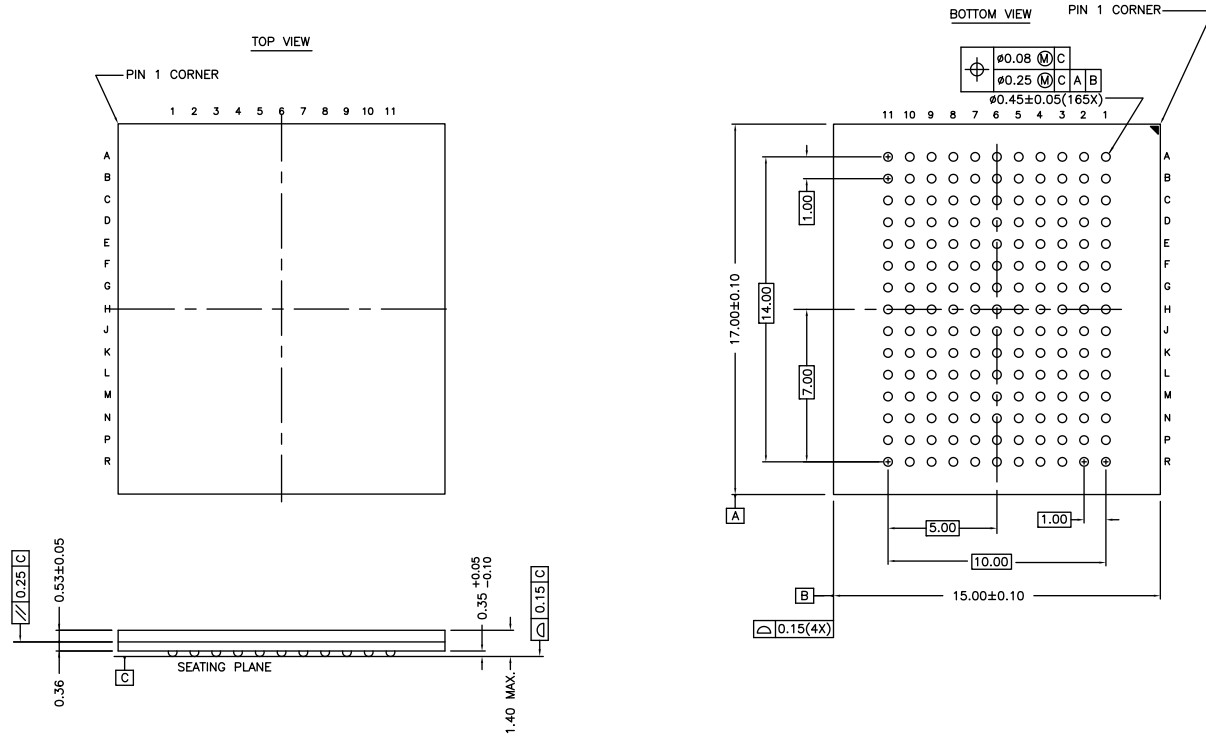

51-85165 *E

Acronyms

Acronym	Description
CE	Chip Enable
CMOS	Complementary Metal Oxide Semiconductor
EIA	Electronic Industries Alliance
FBGA	Fine-Pitch Ball Grid Array
I/O	Input/Output
JEDEC	Joint Electron Devices Engineering Council
OE	Output Enable
SRAM	Static Random Access Memory
TQFP	Thin Quad Flat Pack
TTL	Transistor-Transistor Logic

Document Conventions

Units of Measure

Symbol	Unit of Measure
°C	degree Celsius
MHz	megahertz
μA	microampere
mA	milliampere
mm	millimeter
ms	millisecond
mV	millivolt
ns	nanosecond
Ω	ohm
%	percent
pF	picofarad
V	volt
W	watt

Document History Page

Document Title: CY7C1481BV33, 72-Mbit (2M × 36) Flow-Through SRAM Document Number: 001-74857				
Rev.	ECN No.	Issue Date	Orig. of Change	Description of Change
**	3466988	01/17/2012	GOPA	New data sheet.
*A	3508574	01/25/2012	GOPA	Changed status from Preliminary to Final.
*B	3862706	01/09/2013	PRIT	No technical updates. Completing Sunset Review.
*C	4575228	11/20/2014	PRIT	Updated Functional Description : Added "For a complete list of related documentation, click here ." at the end. Updated Package Diagrams : spec 51-85050 – Changed revision from *D to *E.
*D	5071457	01/04/2016	PRIT	Updated Package Diagrams : spec 51-85165 – Changed revision from *D to *E. Updated to new template. Completing Sunset Review.
*E	5309766	06/15/2016	PRIT	Updated Truth Table . Updated to new template.

Sales, Solutions, and Legal Information

Worldwide Sales and Design Support

Cypress maintains a worldwide network of offices, solution centers, manufacturer's representatives, and distributors. To find the office closest to you, visit us at [Cypress Locations](#).

Products

ARM® Cortex® Microcontrollers	cypress.com/arm
Automotive	cypress.com/automotive
Clocks & Buffers	cypress.com/clocks
Interface	cypress.com/interface
Lighting & Power Control	cypress.com/powerpsoc
Memory	cypress.com/memory
PSoC	cypress.com/psoc
Touch Sensing	cypress.com/touch
USB Controllers	cypress.com/usb
Wireless/RF	cypress.com/wireless

PSoC® Solutions

[PSoC 1](#) | [PSoC 3](#) | [PSoC 4](#) | [PSoC 5LP](#)

Cypress Developer Community

[Forums](#) | [Projects](#) | [Video](#) | [Blogs](#) | [Training](#) | [Components](#)

Technical Support

cypress.com/support

© Cypress Semiconductor Corporation, 2012-2016. This document is the property of Cypress Semiconductor Corporation and its subsidiaries, including Spansion LLC ("Cypress"). This document, including any software or firmware included or referenced in this document ("Software"), is owned by Cypress under the intellectual property laws and treaties of the United States and other countries worldwide. Cypress reserves all rights under such laws and treaties and does not, except as specifically stated in this paragraph, grant any license under its patents, copyrights, trademarks, or other intellectual property rights. If the Software is not accompanied by a license agreement and you do not otherwise have a written agreement with Cypress governing the use of the Software, then Cypress hereby grants you a personal, non-exclusive, nontransferable license (without the right to sublicense) (1) under its copyright rights in the Software (a) for Software provided in source code form, to modify and reproduce the Software solely for use with Cypress hardware products, only internally within your organization, and (b) to distribute the Software in binary code form externally to end users (either directly or indirectly through resellers and distributors), solely for use on Cypress hardware product units, and (2) under those claims of Cypress's patents that are infringed by the Software (as provided by Cypress, unmodified) to make, use, distribute, and import the Software solely for use with Cypress hardware products. Any other use, reproduction, modification, translation, or compilation of the Software is prohibited.

TO THE EXTENT PERMITTED BY APPLICABLE LAW, CYPRESS MAKES NO WARRANTY OF ANY KIND, EXPRESS OR IMPLIED, WITH REGARD TO THIS DOCUMENT OR ANY SOFTWARE OR ACCOMPANYING HARDWARE, INCLUDING, BUT NOT LIMITED TO, THE IMPLIED WARRANTIES OF MERCHANTABILITY AND FITNESS FOR A PARTICULAR PURPOSE. To the extent permitted by applicable law, Cypress reserves the right to make changes to this document without further notice. Cypress does not assume any liability arising out of the application or use of any product or circuit described in this document. Any information provided in this document, including any sample design information or programming code, is provided only for reference purposes. It is the responsibility of the user of this document to properly design, program, and test the functionality and safety of any application made of this information and any resulting product. Cypress products are not designed, intended, or authorized for use as critical components in systems designed or intended for the operation of weapons, weapons systems, nuclear installations, life-support devices or systems, other medical devices or systems (including resuscitation equipment and surgical implants), pollution control or hazardous substances management, or other uses where the failure of the device or system could cause personal injury, death, or property damage ("Unintended Uses"). A critical component is any component of a device or system whose failure to perform can be reasonably expected to cause the failure of the device or system, or to affect its safety or effectiveness. Cypress is not liable, in whole or in part, and you shall and hereby do release Cypress from any claim, damage, or other liability arising from or related to all Unintended Uses of Cypress products. You shall indemnify and hold Cypress harmless from and against all claims, costs, damages, and other liabilities, including claims for personal injury or death, arising from or related to any Unintended Uses of Cypress products.

Cypress, the Cypress logo, Spansion, the Spansion logo, and combinations thereof, PSoC, CapSense, EZ-USB, F-RAM, and Traveo are trademarks or registered trademarks of Cypress in the United States and other countries. For a more complete list of Cypress trademarks, visit cypress.com. Other names and brands may be claimed as property of their respective owners.