

5 Amp 100 Volt High Voltage Schottky  
Barrier Rectifier

**DESCRIPTION**

The UPDS5100H offers a small and powerful surface mount package for a 100 Volt 5 Amp rated Schottky with low forward voltage and very low leakage current. For critical applications requiring very fast switching, these Schottky higher reverse voltage ratings with their “hot carrier” features provide extremely fast switching to replace conventional ultrafast rectifiers. The very low thermal resistance of the PowerDI™5 package design permits cooler operating junction temperatures for minimal reverse leakage currents and lower power loss.

**APPEARANCE**



PowerDI™5

**IMPORTANT:** For the most current data, consult MICROSEMI's website: <http://www.microsemi.com>

**FEATURES**

- Guard Ring Die Construction for Transient Protection
- High Current Low Forward Voltage Drop
- Very Low Leakage Current
- High Junction Temperature Capability
- High Forward Surge Current Capability
- “Green” Molding Compound (No Br, Sb)
- Low inductive parasitics for minimal Ldi/dt effects
- Lead-Free Finish & RoHS Compliant per EU Directive Rev 13.2.2003 (Glass and High Temperature Solder Exemptions Applied per Annex Notes 5 and 7)

**APPLICATIONS / BENEFITS**

- Silicon Schottky (hot carrier) rectifier for minimal  $t_{rr}$  and elimination of reverse-recovery oscillations to reduce need for EMI filtering
- For use in high-frequency switching power supplies, inverters, free wheeling, and polarity protection applications
- Low power loss and high efficiency
- Robust package configuration for pick-and-place handling
- Full-metallic bottom eliminates flux entrapment

**MAXIMUM RATINGS**

- Junction and Storage Temperature ( $T_J$ ,  $T_{STG}$ ): -65 to +150°C
- Average Rectified Output Current ( $I_O$ ): 5 Amps for Single phase, half wave, 60Hz, resistive or inductive load (also see Figure 5). For capacitive load, derate current by 20%.
- Peak Repetitive Reverse Voltage ( $V_{RRM}$ ): 100 V  
Working Peak Reverse Voltage ( $V_{RWM}$ ): 100 V  
DC Blocking Voltage ( $V_R$ ): 100 V
- RMS Reverse Voltage ( $V_{R(RMS)}$ ): 71 V
- Non-Repetitive Peak Forward Surge Current @ 8.3 ms Single half sine-wave Superimposed on Rated Load ( $I_{FSM}$ ): 250A
- Thermal Resistance Junction to case bottom ( $R_{\theta JC}$ ) or Soldering Point ( $R_{\theta JS}$ ): 2.0°C/W
- Thermal Resistance ( $R_{\theta JA}$ ): 110°C/W junction to ambient when mounted on FR-4 PCB, 2 oz. Copper and minimum recommended pad layout (see last page)

**MECHANICAL AND PACKAGING**

- Case Material: Molded Plastic, Environmentally Friendly “Green” Molding Compound. UL Flammability Classification Rating 94V-0
- Moisture sensitivity: Level 1 per J-STD-020C.
- Terminals: Finish – Matte Tin annealed over Copper lead frame (**e3** per JESD97) Solderable per MIL-STD-202, Method 208
- Marking: See marking information on page 3
- Polarity: See Diagram
- Weight: 0.096 grams (approx.)
- Tape & Reel Option: 5000/reel (13”)

**ELECTRICAL CHARACTERISTICS @ 25°C unless specified otherwise**

Part Number	Working Peak Reverse Voltage	Maximum RMS Voltage	Minimum Reverse Breakdown Voltage	Maximum Forward Voltage (Note 2)		Maximum Reverse Current $I_R$ @ $V_{RWM}$ (Note 1)	Maximum Reverse Current $I_R$ @ $V_{RWM}$ , 125°C (Note 1)
	$V_{RWM}$ Volts	$V_{RMS}$ Volts	$V_{BR}$ Volts	$V_F$ @ 5A Volts	$V_F$ @ 10A Volts	$I_R$ $\mu$ A	$I_R$ mA
UPDS5100H	100	71	100	0.71	0.80	10	4.5

NOTE 1: Short duration test pulse used to minimize self-heating effect.

NOTE 2: See Figure 1 for typical values at various temperatures

**GRAPHS**

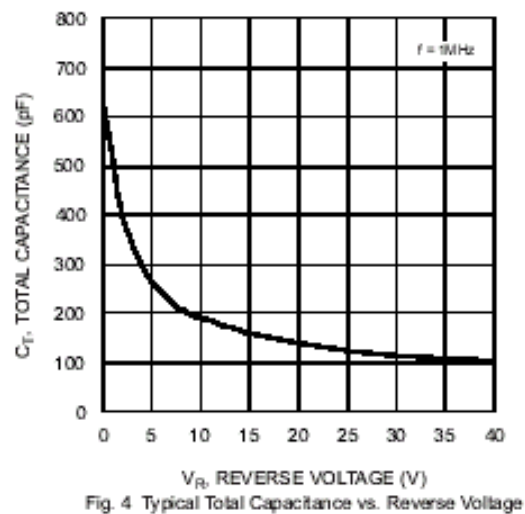
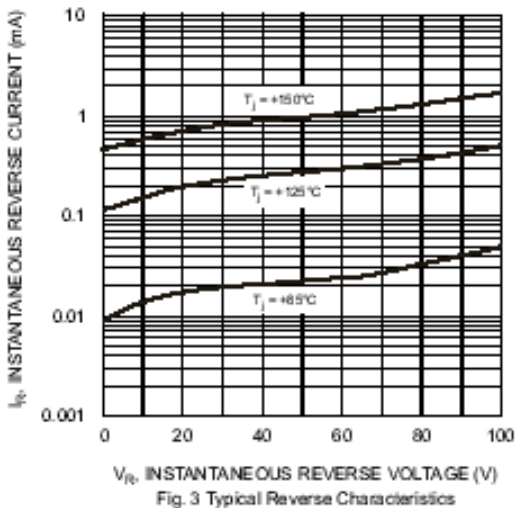
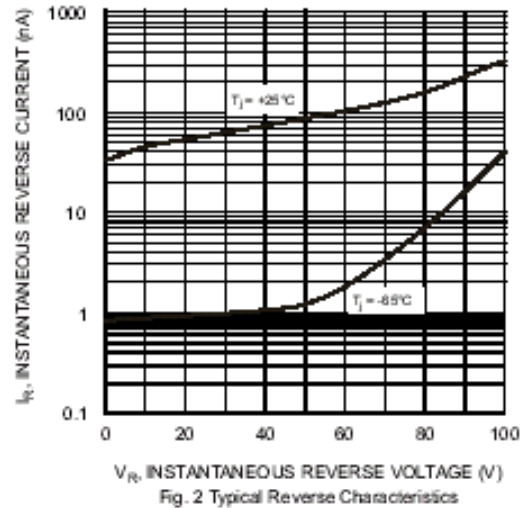
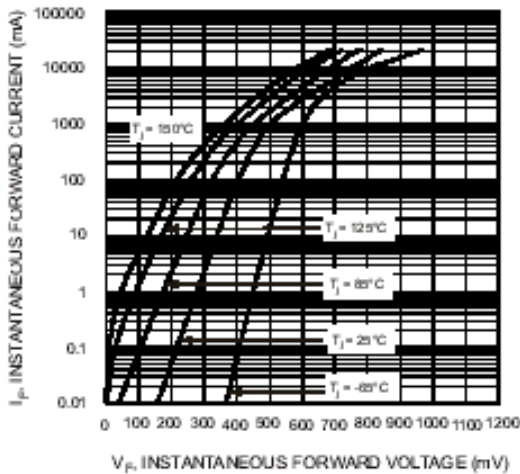

5 Amp 100 Volt High Voltage Schottky Barrier Rectifier

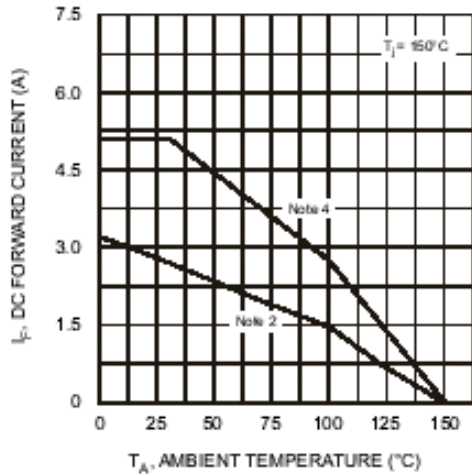

Fig. 5 DC Forward Current Derating

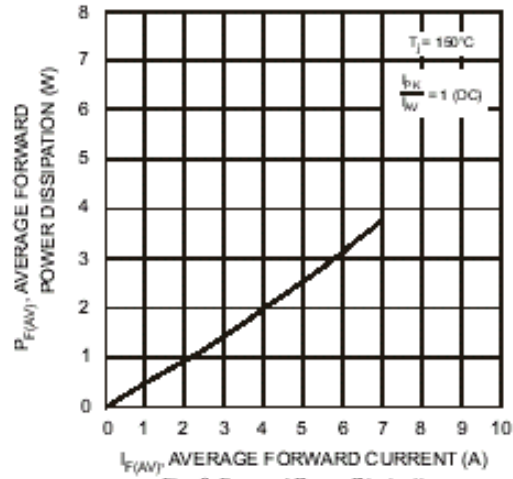

Fig. 6 Forward Power Dissipation

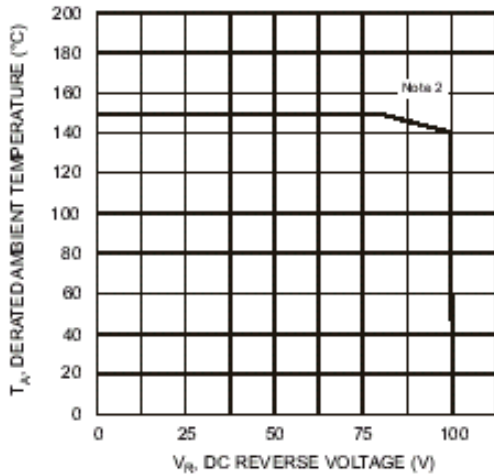

Fig. 7 Operating Temperature Derating

NOTE 2: FR-4 PCB, 2 oz. Copper, minimum recommended pad layout.

NOTE 3: Short duration test pulse used to minimize self-heating effects.

NOTE 4: Polyimide PCB, 2 oz. Copper. Cathode pad dimensions 9.4mm x 7.2mm. Anode pad dimensions 2.7mm x 1.6mm.

**MARKING INFORMATION**



S5100H = Product type marking code.  
 MSC = Manufacturers' code marking  
 YYWW = Date code marking  
 YY = Last digit of year ex: 04 for 2004  
 WW = Week code 01 to 52

**DIMENSIONS AND SCHEMATIC**

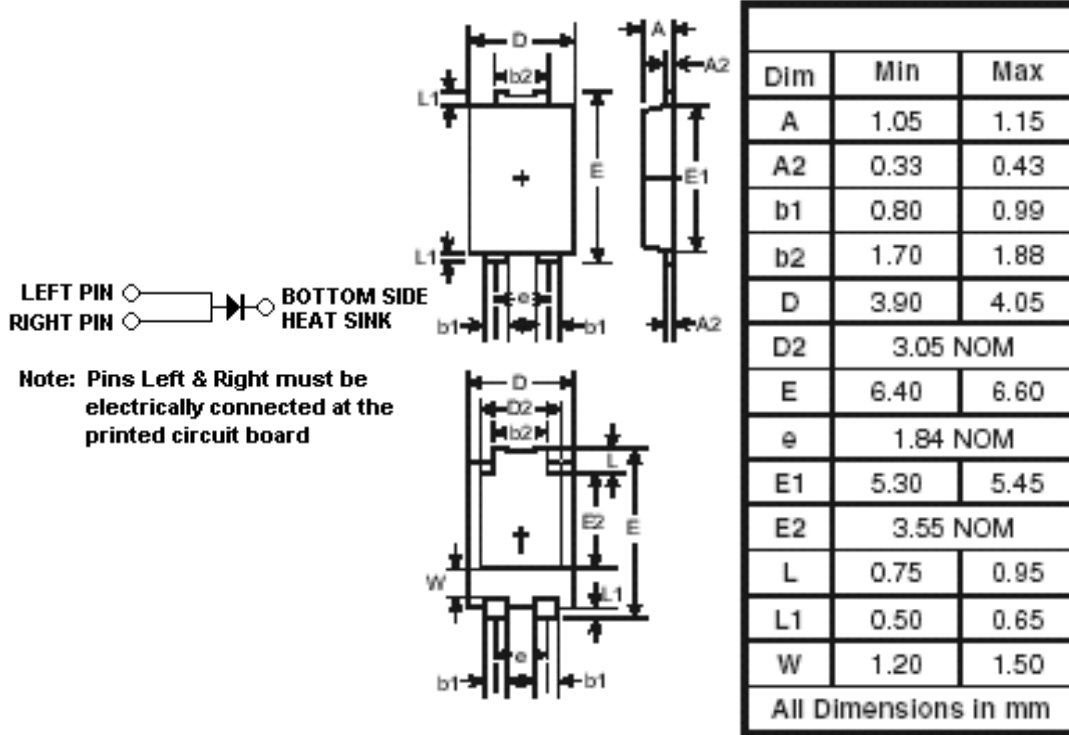

**PowerDI™ 5**

**MOUNTING PAD DIMENSIONS**

PAD dimensions (mm)	
Z	6.6
X1	1.4
X2	3.6
Y1	0.8
Y2	4.7
C	3.87
E1	0.9

