

High voltage power Schottky rectifier

Features

- Negligible switching losses
- High junction temperature capability
- Low leakage current
- Good trade-off between leakage current and forward voltage drop
- Avalanche capability specified

Description

Axial power Schottky rectifier suited for switch mode power supply and high frequency DC/DC converters. Packaged in DO-41, this device is intended for use in low voltage, high frequency inverters and small battery chargers.

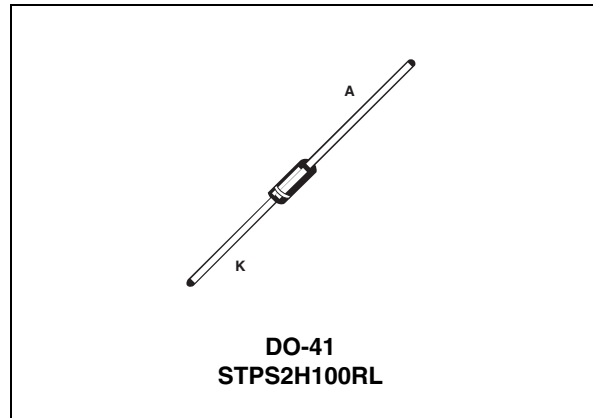

Table 1. Device summary

Symbol	Value
$I_{F(AV)}$	2 A
V_{RRM}	100 V
T_j (max)	175 °C
V_F (max)	0.70 V

1 Characteristics

Table 2. Absolute ratings (limiting values)

Symbol	Parameter	Value	Unit
V _{RRM}	Repetitive peak reverse voltage	100	V
I _{F(RMS)}	Forward rms current	10	A
I _{F(AV)}	Average forward current	T _L = 120 °C, δ = 0.5	A
I _{FSM}	Surge non repetitive forward current	t _p = 10 ms sinusoidal	A
I _{RRM}	Repetitive peak reverse current	t _p = 2 ms square, F = 1 kHz	A
P _{ARM}	Repetitive peak avalanche power	t _p = 1 μs, T _j = 25 °C	W
T _{stg}	Storage temperature range	-65 to + 175	°C
T _j	Operating junction temperature ⁽¹⁾	175	°C
dV/dt	Critical rate of rise of reverse voltage	10000	V/μs

1. $\frac{dP_{tot}}{dT_j} < \frac{1}{R_{th(j-a)}}$ condition to avoid thermal runaway for a diode on its own heatsink

Table 3. Thermal resistance

Symbol	Parameter	Value	Unit
R _{th(j-a)}	Junction to ambient	100	°C/W
R _{th(j-l)}	Junction to lead	35	

Lead length = 10 mm

Table 4. Static electrical characteristics

Symbol	Parameter	Test conditions	Min.	Typ.	Max.	Unit
I _R ⁽¹⁾	Reverse leakage current	T _j = 25 °C	V _R = V _{RRM}		1	μA
		T _j = 125 °C		0.2	0.5	mA
V _F ⁽²⁾	Forward voltage drop	T _j = 25 °C	I _F = 2 A		0.86	V
		T _j = 125 °C		0.65	0.70	
		T _j = 25 °C	I _F = 4 A		0.92	
		T _j = 125 °C		0.72	0.78	

1. Pulse test: t_p = 5 ms, δ < 2%

2. Pulse test: t_p = 380 μs, δ < 2%

To evaluate the conduction losses use the following equation:

$$P = 0.62 \times I_{F(AV)} + 0.04 I_{F(RMS)}^2$$

Figure 1. Average forward current versus ambient temperature ($\delta = 0.5$)

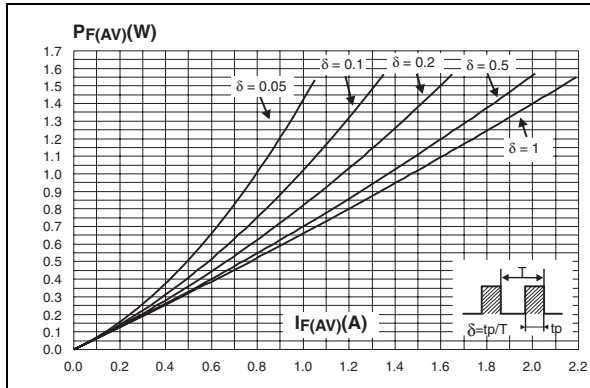

Figure 2. Average forward current versus ambient temperature

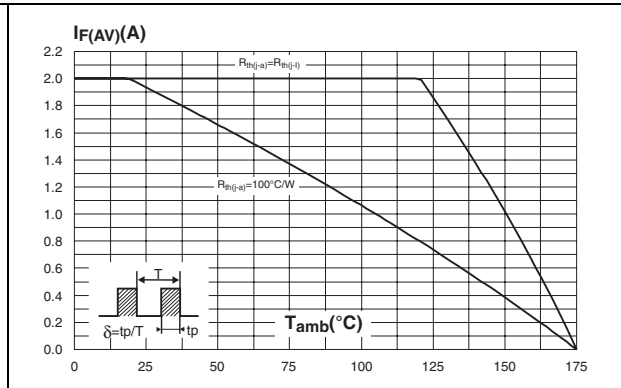

Figure 3. Normalized avalanche power derating versus pulse duration

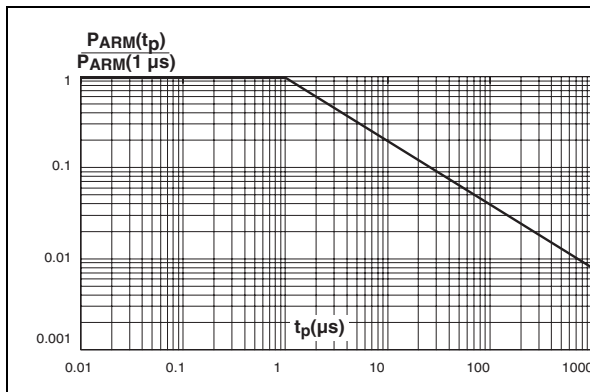

Figure 4. Normalized avalanche power derating versus junction temperature

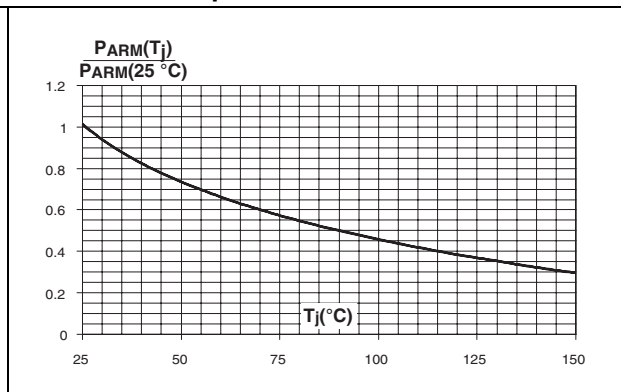

Figure 5. Non repetitive surge peak forward current versus overload duration (maximum values)

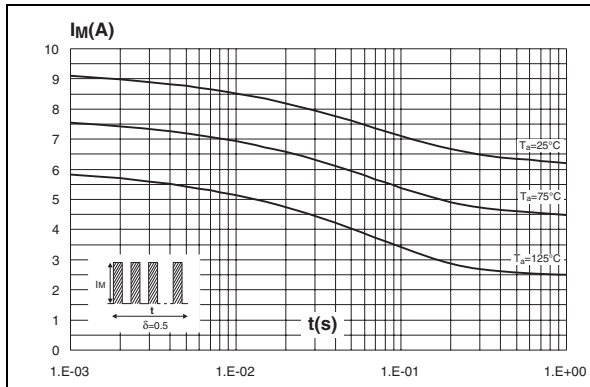

Figure 6. Relative variation of thermal impedance junction to ambient versus pulse duration

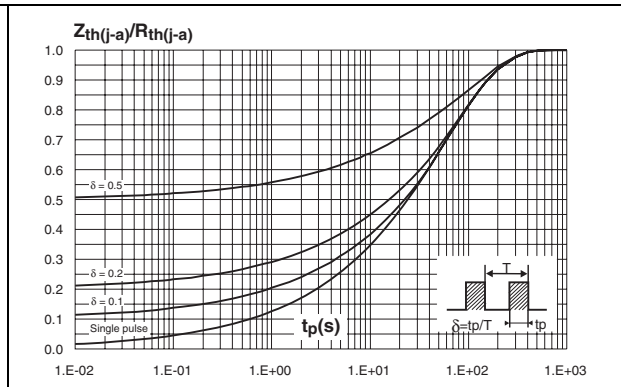

Figure 7. Reverse leakage current versus reverse voltage applied (typical values)

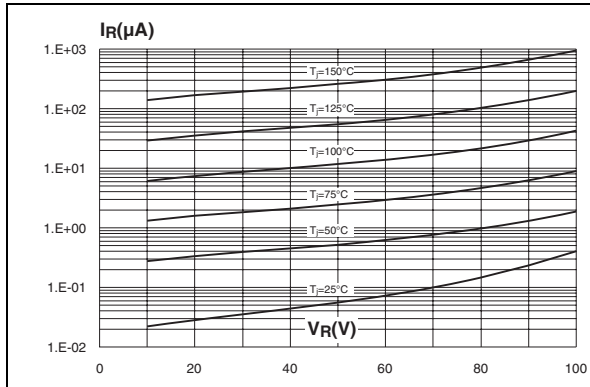

Figure 8. Junction capacitance versus reverse voltage applied (typical values)

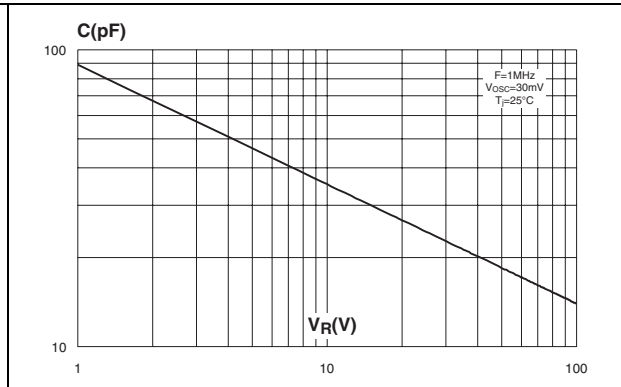

Figure 9. Forward voltage drop versus forward current (low level)

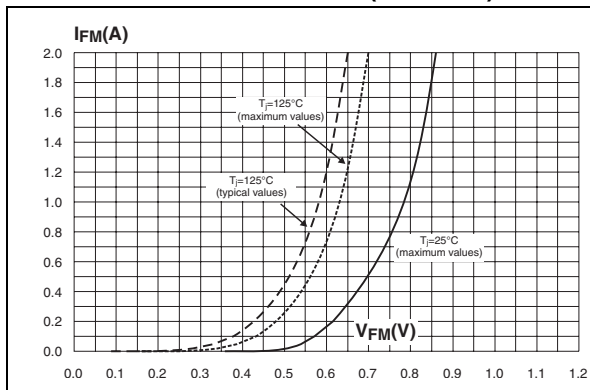

Figure 10. Forward voltage drop versus forward current (high level)

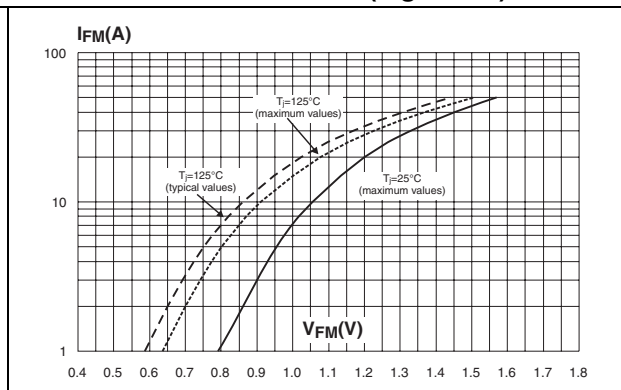
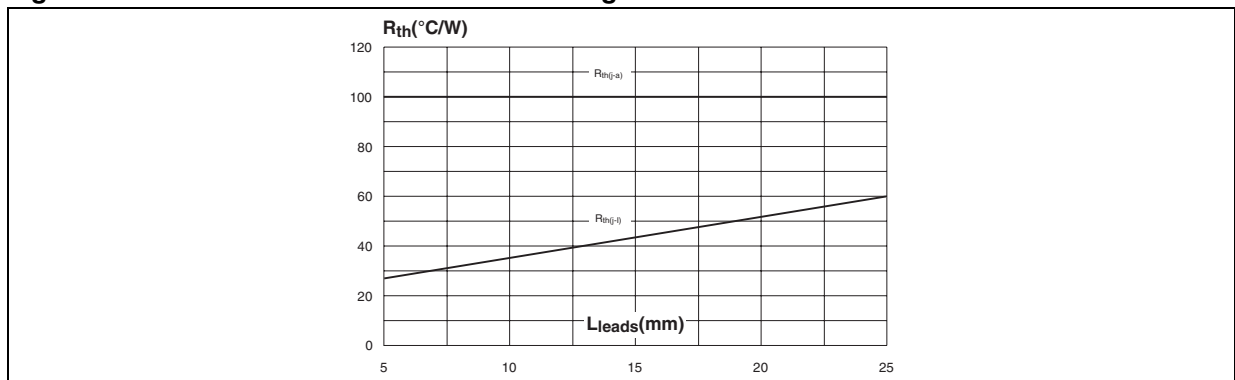

Figure 11. Thermal resistance versus lead length



2 Package information

- Epoxy meets UL94, V0
- Band indicates cathode

In order to meet environmental requirements, ST offers these devices in different grades of ECOPACK® packages, depending on their level of environmental compliance. ECOPACK® specifications, grade definitions and product status are available at: www.st.com. ECOPACK® is an ST trademark.

Table 5. DO-41 (plastic) dimensions

Ref.	Dimensions			
	Millimeters		Inches	
	Min.	Max.	Min.	Max.
A	4.07	5.20	0.160	0.205
B	2.04	2.71	0.080	0.107
C	25.4		1	
D	0.71	0.86	0.028	0.034

3 Ordering information

Table 6. Ordering information

Order code	Marking	Package	Weight	Base qty	Delivery mode
STPS2H100	STPS2H100 Cathode ring	DO-41	0.34 g	2000	Ammopack
STPS2H100RL	STPS2H100 Cathode ring			5000	Tape and reel

4 Revision history

Table 7. Document revision history

Date	Revision	Changes
Jul-2003	2A	Last update.
23-Jun-2009	3	Updated dimension C in table 5.
05-Oct-2009	4	Updated table 5 package dimensions.

Please Read Carefully:

Information in this document is provided solely in connection with ST products. STMicroelectronics NV and its subsidiaries ("ST") reserve the right to make changes, corrections, modifications or improvements, to this document, and the products and services described herein at any time, without notice.

All ST products are sold pursuant to ST's terms and conditions of sale.

Purchasers are solely responsible for the choice, selection and use of the ST products and services described herein, and ST assumes no liability whatsoever relating to the choice, selection or use of the ST products and services described herein.

No license, express or implied, by estoppel or otherwise, to any intellectual property rights is granted under this document. If any part of this document refers to any third party products or services it shall not be deemed a license grant by ST for the use of such third party products or services, or any intellectual property contained therein or considered as a warranty covering the use in any manner whatsoever of such third party products or services or any intellectual property contained therein.

UNLESS OTHERWISE SET FORTH IN ST'S TERMS AND CONDITIONS OF SALE ST DISCLAIMS ANY EXPRESS OR IMPLIED WARRANTY WITH RESPECT TO THE USE AND/OR SALE OF ST PRODUCTS INCLUDING WITHOUT LIMITATION IMPLIED WARRANTIES OF MERCHANTABILITY, FITNESS FOR A PARTICULAR PURPOSE (AND THEIR EQUIVALENTS UNDER THE LAWS OF ANY JURISDICTION), OR INFRINGEMENT OF ANY PATENT, COPYRIGHT OR OTHER INTELLECTUAL PROPERTY RIGHT.

UNLESS EXPRESSLY APPROVED IN WRITING BY AN AUTHORIZED ST REPRESENTATIVE, ST PRODUCTS ARE NOT RECOMMENDED, AUTHORIZED OR WARRANTED FOR USE IN MILITARY, AIR CRAFT, SPACE, LIFE SAVING, OR LIFE SUSTAINING APPLICATIONS, NOR IN PRODUCTS OR SYSTEMS WHERE FAILURE OR MALFUNCTION MAY RESULT IN PERSONAL INJURY, DEATH, OR SEVERE PROPERTY OR ENVIRONMENTAL DAMAGE. ST PRODUCTS WHICH ARE NOT SPECIFIED AS "AUTOMOTIVE GRADE" MAY ONLY BE USED IN AUTOMOTIVE APPLICATIONS AT USER'S OWN RISK.

Resale of ST products with provisions different from the statements and/or technical features set forth in this document shall immediately void any warranty granted by ST for the ST product or service described herein and shall not create or extend in any manner whatsoever, any liability of ST.

ST and the ST logo are trademarks or registered trademarks of ST in various countries.

Information in this document supersedes and replaces all information previously supplied.

The ST logo is a registered trademark of STMicroelectronics. All other names are the property of their respective owners.

© 2009 STMicroelectronics - All rights reserved

STMicroelectronics group of companies

Australia - Belgium - Brazil - Canada - China - Czech Republic - Finland - France - Germany - Hong Kong - India - Israel - Italy - Japan - Malaysia - Malta - Morocco - Philippines - Singapore - Spain - Sweden - Switzerland - United Kingdom - United States of America

www.st.com