

## N-Channel FREDFET

Power MOS 8™ is a high speed, high voltage N-channel switch-mode power MOSFET. This 'FREDFET' version has a drain-source (body) diode that has been optimized for high reliability in ZVS phase shifted bridge and other circuits through reduced  $t_{rr}$ , soft recovery, and high recovery  $dv/dt$  capability. Low gate charge, high gain, and a greatly reduced ratio of  $C_{rSS}/C_{iSS}$  result in excellent noise immunity and low switching loss. The intrinsic gate resistance and capacitance of the poly-silicon gate structure help control  $di/dt$  during switching, resulting in low EMI and reliable paralleling, even when switching at very high frequency.

**APT41F100J**

Single die FREDFET

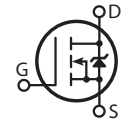

### FEATURES

- Fast switching with low EMI
- Low  $t_{rr}$  for high reliability
- Ultra low  $C_{rSS}$  for improved noise immunity
- Low gate charge
- Avalanche energy rated
- RoHS compliant 

### TYPICAL APPLICATIONS

- ZVS phase shifted and other full bridge
- Half bridge
- PFC and other boost converter
- Buck converter
- Single and two switch forward
- Flyback

### Absolute Maximum Ratings

Symbol	Parameter	Ratings	Unit
$I_D$	Continuous Drain Current @ $T_C = 25^\circ C$	42	A
	Continuous Drain Current @ $T_C = 100^\circ C$	27	
$I_{DM}$	Pulsed Drain Current <sup>①</sup>	260	
$V_{GS}$	Gate-Source Voltage	$\pm 30$	V
$E_{AS}$	Single Pulse Avalanche Energy <sup>②</sup>	4075	mJ
$I_{AR}$	Avalanche Current, Repetitive or Non-Repetitive	33	A

### Thermal and Mechanical Characteristics

Symbol	Characteristic	Min	Typ	Max	Unit
$P_D$	Total Power Dissipation @ $T_C = 25^\circ C$			960	W
$R_{\theta JC}$	Junction to Case Thermal Resistance			0.13	$^\circ C/W$
$R_{\theta CS}$	Case to Sink Thermal Resistance, Flat, Greased Surface		0.15		
$T_J, T_{STG}$	Operating and Storage Junction Temperature Range	-55		150	$^\circ C$
$V_{Isolation}$	RMS Voltage (50-60Hz Sinusoidal Waveform from Terminals to Mounting Base for 1 Min.)	2500			V
$W_T$	Package Weight		1.03		oz
			29.2		g
Torque	Terminals and Mounting Screws.			10	in·lbf
				1.1	N·m

**Static Characteristics**
**T<sub>J</sub> = 25°C unless otherwise specified**
**APT41F100J**

Symbol	Parameter	Test Conditions	Min	Typ	Max	Unit
V <sub>BR(DSS)</sub>	Drain-Source Breakdown Voltage	V <sub>GS</sub> = 0V, I <sub>D</sub> = 250μA	1000			V
ΔV <sub>BR(DSS)</sub> /ΔT <sub>J</sub>	Breakdown Voltage Temperature Coefficient	Reference to 25°C, I <sub>D</sub> = 250μA		1.15		V/°C
R <sub>DS(on)</sub>	Drain-Source On Resistance <sup>③</sup>	V <sub>GS</sub> = 10V, I <sub>D</sub> = 33A		0.18	0.20	Ω
V <sub>GS(th)</sub>	Gate-Source Threshold Voltage	V <sub>GS</sub> = V <sub>DS</sub> , I <sub>D</sub> = 5mA	2.5	4	5	V
ΔV <sub>GS(th)</sub> /ΔT <sub>J</sub>	Threshold Voltage Temperature Coefficient			-10		mV/°C
I <sub>DSS</sub>	Zero Gate Voltage Drain Current	V <sub>DS</sub> = 1000V V <sub>GS</sub> = 0V			250 1000	μA
I <sub>GSS</sub>	Gate-Source Leakage Current	V <sub>GS</sub> = ±30V			±100	nA

**Dynamic Characteristics**
**T<sub>J</sub> = 25°C unless otherwise specified**

Symbol	Parameter	Test Conditions	Min	Typ	Max	Unit
g <sub>fs</sub>	Forward Transconductance	V <sub>DS</sub> = 50V, I <sub>D</sub> = 33A		75		S
C <sub>iss</sub>	Input Capacitance	V <sub>GS</sub> = 0V, V <sub>DS</sub> = 25V f = 1MHz		18500		pF
C <sub>rss</sub>	Reverse Transfer Capacitance			245		
C <sub>oss</sub>	Output Capacitance			1555		
C <sub>o(cr)</sub> <sup>④</sup>	Effective Output Capacitance, Charge Related	V <sub>GS</sub> = 0V, V <sub>DS</sub> = 0V to 667V		635		pF
C <sub>o(er)</sub> <sup>⑤</sup>	Effective Output Capacitance, Energy Related			325		
Q <sub>g</sub>	Total Gate Charge	V <sub>GS</sub> = 0 to 10V, I <sub>D</sub> = 33A, V <sub>DS</sub> = 500V		570		nC
Q <sub>gs</sub>	Gate-Source Charge			100		
Q <sub>gd</sub>	Gate-Drain Charge			270		
t <sub>d(on)</sub>	Turn-On Delay Time	<b>Resistive Switching</b> V <sub>DD</sub> = 667V, I <sub>D</sub> = 33A R <sub>G</sub> = 2.2Ω <sup>⑥</sup> , V <sub>GG</sub> = 15V		55		ns
t <sub>r</sub>	Current Rise Time			55		
t <sub>d(off)</sub>	Turn-Off Delay Time			235		
t <sub>f</sub>	Current Fall Time			55		

**Source-Drain Diode Characteristics**

Symbol	Parameter	Test Conditions	Min	Typ	Max	Unit
I <sub>S</sub>	Continuous Source Current (Body Diode)	MOSFET symbol showing the integral reverse p-n junction diode (body diode)			42	A
I <sub>SM</sub>	Pulsed Source Current (Body Diode) <sup>①</sup>				260	
V <sub>SD</sub>	Diode Forward Voltage	I <sub>SD</sub> = 33A, T <sub>J</sub> = 25°C, V <sub>GS</sub> = 0V			1.0	V
t <sub>rr</sub>	Reverse Recovery Time	I <sub>SD</sub> = 33A <sup>③</sup> V <sub>DD</sub> = 100V di <sub>SD</sub> /dt = 100A/μs	T <sub>J</sub> = 25°C		400	ns
			T <sub>J</sub> = 125°C		800	
Q <sub>rr</sub>	Reverse Recovery Charge		T <sub>J</sub> = 25°C		3.3	μC
			T <sub>J</sub> = 125°C		8.0	
I <sub>rrm</sub>	Reverse Recovery Current	T <sub>J</sub> = 25°C		17.2	A	
		T <sub>J</sub> = 125°C		24.6		
dv/dt	Peak Recovery dv/dt	I <sub>SD</sub> ≤ 33A, di/dt ≤ 1000A/μs, V <sub>DD</sub> = 667V, T <sub>J</sub> = 125°C			25	V/ns

① Repetitive Rating: Pulse width and case temperature limited by maximum junction temperature.

② Starting at T<sub>J</sub> = 25°C, L = 7.48mH, R<sub>G</sub> = 25Ω, I<sub>AS</sub> = 33A.

③ Pulse test: Pulse Width < 380μs, duty cycle < 2%.

④ C<sub>o(cr)</sub> is defined as a fixed capacitance with the same stored charge as C<sub>oss</sub> with V<sub>DS</sub> = 67% of V<sub>(BR)DSS</sub>.

⑤ C<sub>o(er)</sub> is defined as a fixed capacitance with the same stored energy as C<sub>oss</sub> with V<sub>DS</sub> = 67% of V<sub>(BR)DSS</sub>. To calculate C<sub>o(er)</sub> for any value of V<sub>DS</sub> less than V<sub>(BR)DSS</sub>, use this equation: C<sub>o(er)</sub> = -5.37E-7/V<sub>DS</sub><sup>2</sup> + 9.48E-8/V<sub>DS</sub> + 1.83E-10.

⑥ R<sub>G</sub> is external gate resistance, not including internal gate resistance or gate driver impedance. (MIC4452)

Microsemi reserves the right to change, without notice, the specifications and information contained herein.

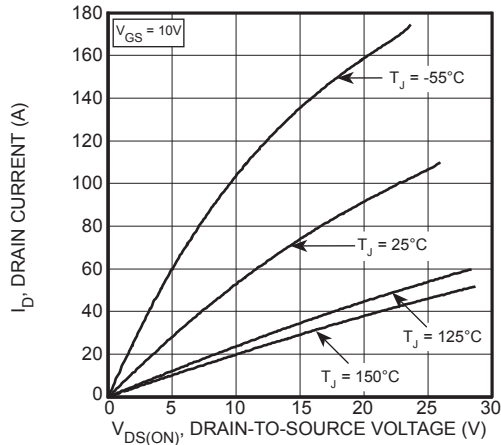

Figure 1, Output Characteristics

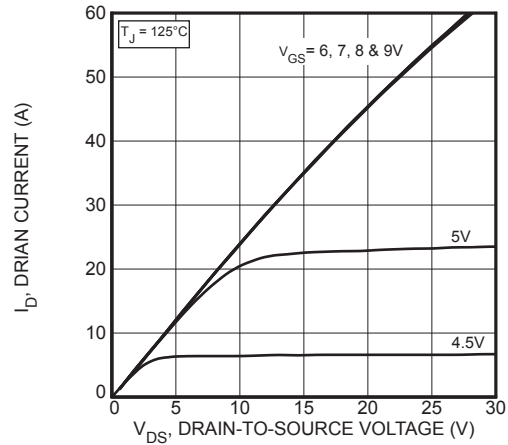

Figure 2, Output Characteristics

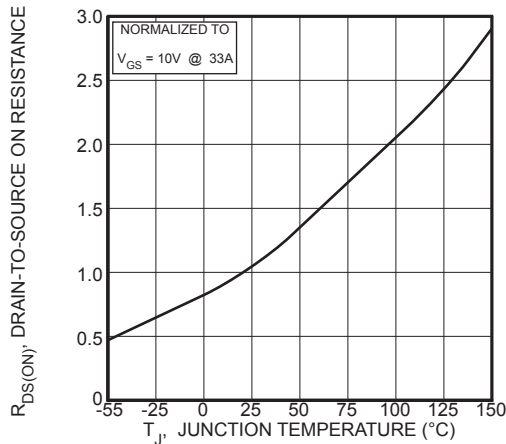

Figure 3,  $R_{DS(ON)}$  vs Junction Temperature

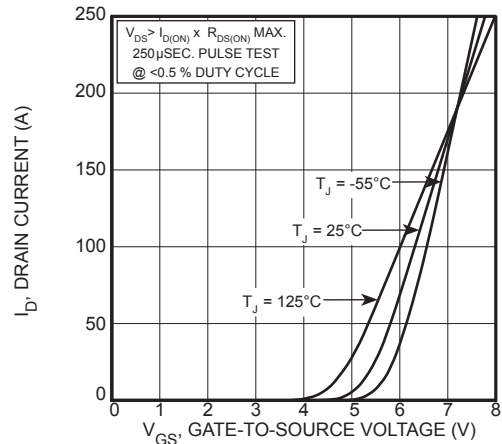

Figure 4, Transfer Characteristics

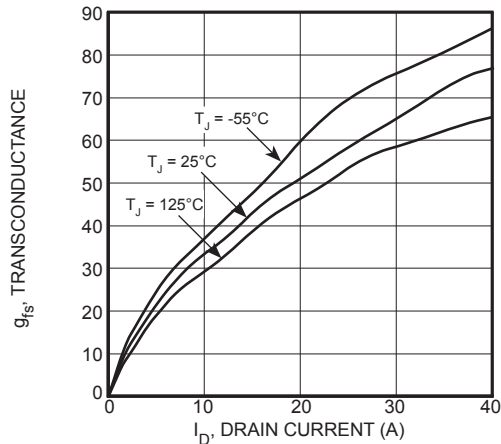

Figure 5, Gain vs Drain Current

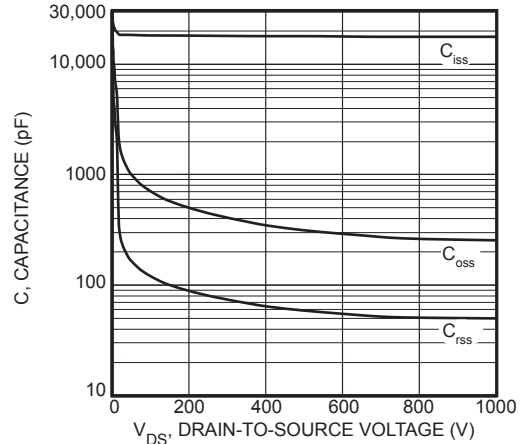

Figure 6, Capacitance vs Drain-to-Source Voltage

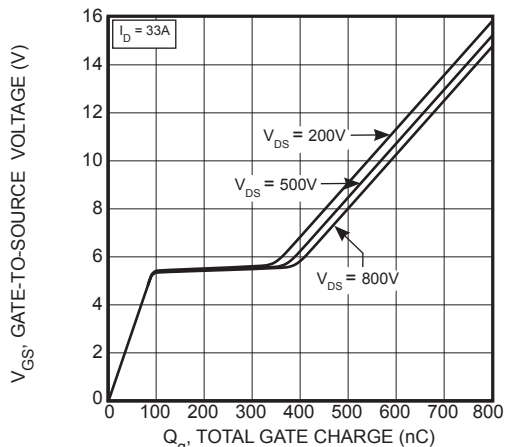

Figure 7, Gate Charge vs Gate-to-Source Voltage

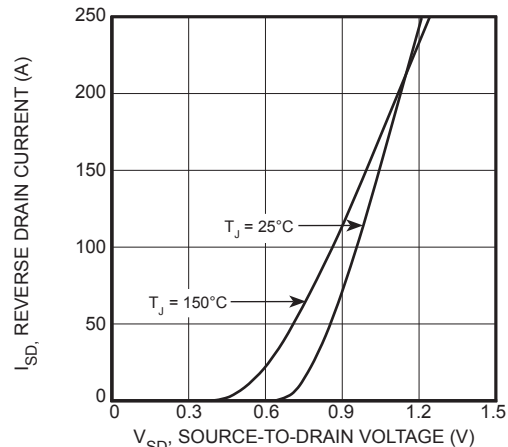

Figure 8, Reverse Drain Current vs Source-to-Drain Voltage

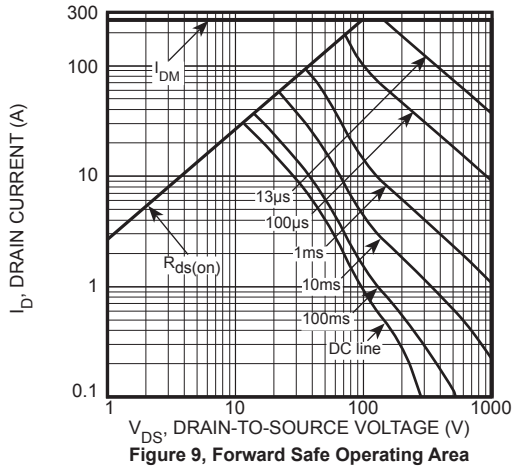

Figure 9, Forward Safe Operating Area

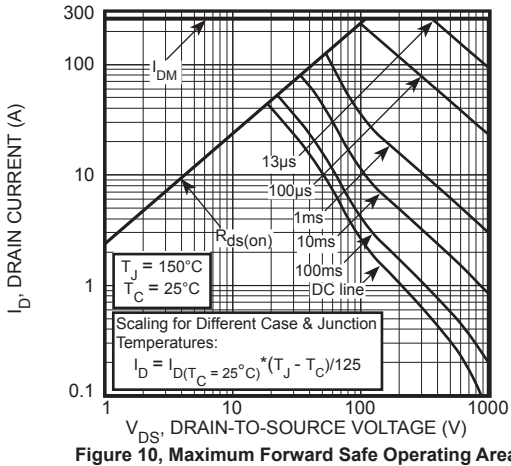

Figure 10, Maximum Forward Safe Operating Area

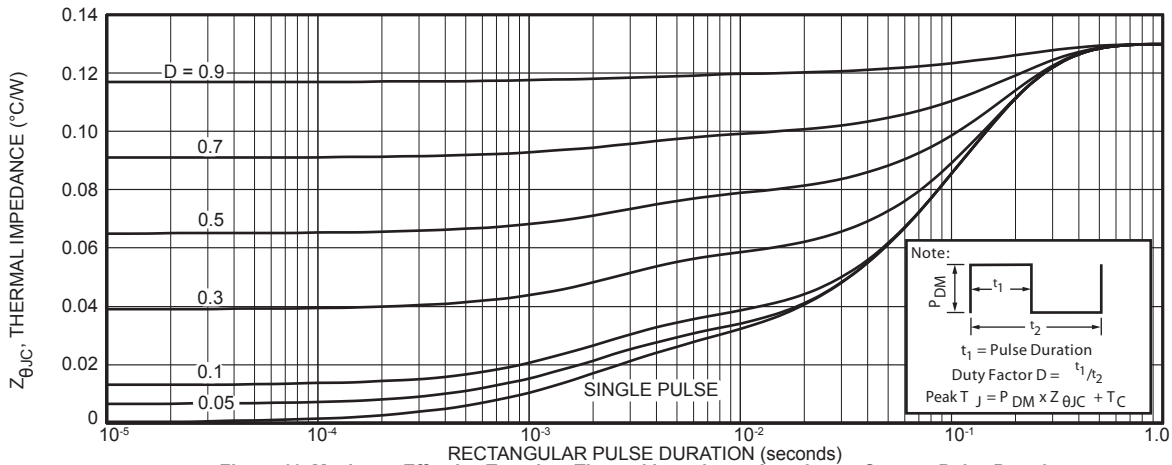
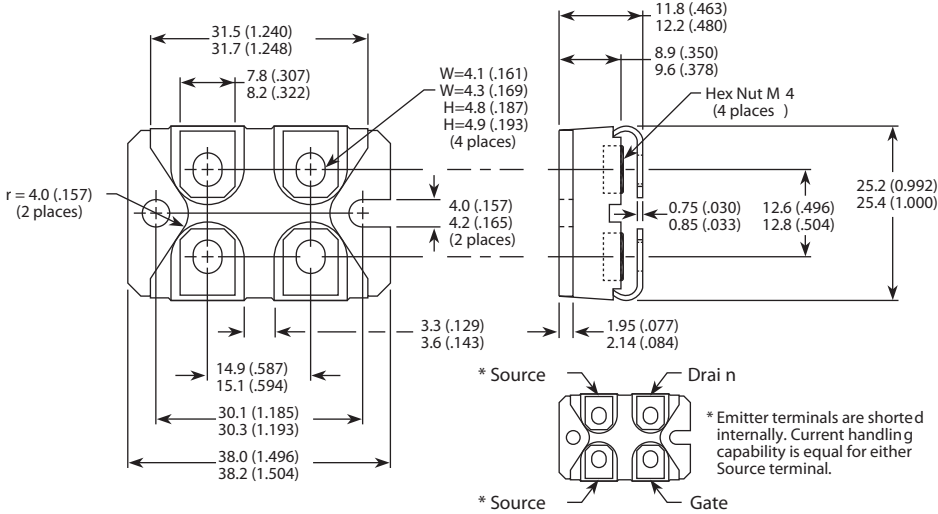

Figure 11. Maximum Effective Transient Thermal Impedance Junction-to-Case vs Pulse Duration

SOT-227 (ISOTOP®) Package Outline



Dimensions in Millimeters and (Inches)