

## Features

- Complementary Pair MOSFETs
- Low On-Resistance
  - N-Channel: 35mΩ @ 10V  
61mΩ @ 4.5V
  - P-Channel: 65mΩ @ -10V  
115mΩ @ -4.5V
- Low Gate Threshold Voltage
- Low Input Capacitance
- Fast Switching Speed
- Low Input/Output Leakage
- **Lead Free By Design/RoHS Compliant (Note 2)**
- **"Green" Device (Note 3)**
- **Qualified to AEC-Q101 Standards for High Reliability**

## Mechanical Data

- Case: SOP-8L
- Case Material: Molded Plastic, "Green" Molding Compound. UL Flammability Classification Rating 94V-0
- Moisture Sensitivity: Level 1 per J-STD-020D
- Terminals Connections: See Diagram
- Terminals: Finish - Matte Tin annealed over Copper lead frame. Solderable per MIL-STD-202, Method 208
- Marking Information: See Page 6
- Ordering Information: See Page 6
- Weight: 0.072g (approximate)

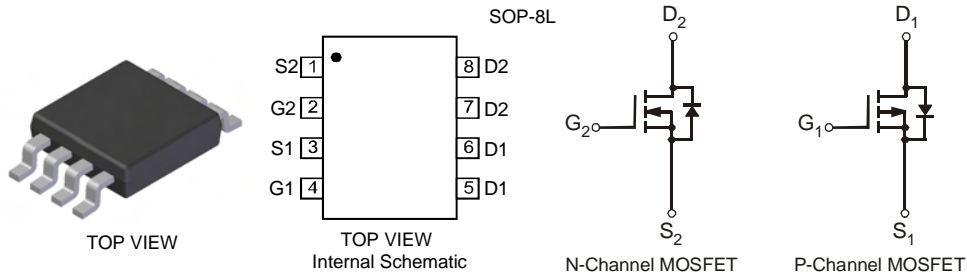

## Maximum Ratings N-CHANNEL @ $T_A = 25^\circ\text{C}$ unless otherwise specified

Characteristic	Symbol	Value	Unit
Drain Source Voltage	$V_{DSS}$	30	V
Gate-Source Voltage	$V_{GSS}$	$\pm 20$	V
Drain Current (Note 1)	$I_D$	6.9 5.8	A
		$T_A = 25^\circ\text{C}$ $T_A = 70^\circ\text{C}$	
Pulsed Drain Current (Note 4)	$I_{DM}$	30	A

## Maximum Ratings P-CHANNEL @ $T_A = 25^\circ\text{C}$ unless otherwise specified

Characteristic	Symbol	Value	Unit
Drain Source Voltage	$V_{DSS}$	-30	V
Gate-Source Voltage	$V_{GSS}$	$\pm 20$	V
Drain Current (Note 1)	$I_D$	-5 -4.2	A
		$T_A = 25^\circ\text{C}$ $T_A = 70^\circ\text{C}$	
Pulsed Drain Current (Note 4)	$I_{DM}$	-20	A

## Thermal Characteristics @ $T_A = 25^\circ\text{C}$ unless otherwise specified

Characteristic	Symbol	Value	Unit
Power Dissipation (Note 1)	$P_D$	2	W
Thermal Resistance, Junction to Ambient	$R_{\theta JA}$	62.5	$^\circ\text{C}/\text{W}$
Operating and Storage Temperature Range	$T_J, T_{STG}$	-55 to +150	$^\circ\text{C}$

- Notes:
1. Device mounted on 2oz. copper pads on 2" x 2" FR4 PCB.
  2. No purposefully added lead.
  3. Diodes Inc.'s "Green" policy can be found on our website at [http://www.diodes.com/products/lead\\_free/index.php](http://www.diodes.com/products/lead_free/index.php).
  4. Repetitive rating, pulse width limited by junction temperature.

**Electrical Characteristics N-CHANNEL** @ $T_A = 25^\circ\text{C}$  unless otherwise specified

Characteristic	Symbol	Min	Typ	Max	Unit	Test Condition
<b>OFF CHARACTERISTICS (Note 5)</b>						
Drain-Source Breakdown Voltage	$BV_{DSS}$	30	—	—	V	$V_{GS} = 0V, I_D = 250\mu A$
Zero Gate Voltage Drain Current	$I_{DSS}$	—	—	1	$\mu A$	$V_{DS} = 24V, V_{GS} = 0V$
Gate-Source Leakage	$I_{GSS}$	—	—	$\pm 100$	nA	$V_{GS} = \pm 20V, V_{DS} = 0V$
<b>ON CHARACTERISTICS (Note 5)</b>						
Gate Threshold Voltage	$V_{GS(th)}$	1	—	2.1	V	$V_{DS} = V_{GS}, I_D = 250\mu A$
Static Drain-Source On-Resistance	$R_{DS(on)}$	—	28 51	35 61	m $\Omega$	$V_{GS} = 10V, I_D = 6.9A$ $V_{GS} = 4.5V, I_D = 5.0A$
Forward Transfer Admittance	$ Y_{fs} $	—	7.7	—	S	$V_{DS} = 5V, I_D = 6.9A$
Diode Forward Voltage (Note 5)	$V_{SD}$	0.5	—	1.2	V	$V_{GS} = 0V, I_S = 1A$
<b>DYNAMIC CHARACTERISTICS</b>						
Input Capacitance	$C_{iss}$	—	384	—	pF	$V_{DS} = 15V, V_{GS} = 0V, f = 1.0\text{MHz}$
Output Capacitance	$C_{oss}$	—	67	—	pF	
Reverse Transfer Capacitance	$C_{rss}$	—	48	—	pF	
Gate Resistance	$R_G$	—	1.3	—	$\Omega$	$V_{GS} = 0V, V_{DS} = 0V, f = 1\text{MHz}$
<b>SWITCHING CHARACTERISTICS</b>						
Total Gate Charge	$Q_g$	—	4.3 8.6	—	nC	$V_{DS} = 10V, V_{GS} = 4.5V, I_D = 10A$ $V_{DS} = 10V, V_{GS} = 10V, I_D = 10A$
Gate-Source Charge	$Q_{gs}$	—	1.2	—		$V_{DS} = 10V, V_{GS} = 10V, I_D = 10A$
Gate-Drain Charge	$Q_{gd}$	—	2.5	—		$V_{DS} = 10V, V_{GS} = 10V, I_D = 10A$

**Electrical Characteristics P-CHANNEL** @ $T_A = 25^\circ\text{C}$  unless otherwise specified

Characteristic	Symbol	Min	Typ	Max	Unit	Test Condition
<b>OFF CHARACTERISTICS (Note 5)</b>						
Drain-Source Breakdown Voltage	$BV_{DSS}$	-30	—	—	V	$V_{GS} = 0V, I_D = -250\mu A$
Zero Gate Voltage Drain Current	$I_{DSS}$	—	—	-1.0	$\mu A$	$V_{DS} = -24V, V_{GS} = 0V$
Gate-Source Leakage	$I_{GSS}$	—	—	$\pm 100$	nA	$V_{GS} = \pm 20V, V_{DS} = 0V$
<b>ON CHARACTERISTICS (Note 5)</b>						
Gate Threshold Voltage	$V_{GS(th)}$	-1	—	-2.1	V	$V_{DS} = V_{GS}, I_D = -250\mu A$
Static Drain-Source On-Resistance	$R_{DS(on)}$	—	56 98	65 115	m $\Omega$	$V_{GS} = -10V, I_D = -5A$ $V_{GS} = -4.5V, I_D = -4A$
Forward Transfer Admittance	$ Y_{fs} $	—	—	5.2	S	$V_{DS} = -10V, I_D = -5A$
Diode Forward Voltage (Note 5)	$V_{SD}$	-0.5	—	-1.2	V	$V_{GS} = 0V, I_S = -2.6A$
<b>DYNAMIC CHARACTERISTICS</b>						
Input Capacitance	$C_{iss}$	—	336	—	pF	$V_{DS} = -25V, V_{GS} = 0V, f = 1.0\text{MHz}$
Output Capacitance	$C_{oss}$	—	70	—	pF	
Reverse Transfer Capacitance	$C_{rss}$	—	49	—	pF	
Gate Resistance	$R_G$	—	4.6	—	$\Omega$	$V_{GS} = 0V, V_{DS} = 0V, f = 1\text{MHz}$
<b>SWITCHING CHARACTERISTICS</b>						
Total Gate Charge	$Q_g$	—	4.0 7.8	—	nC	$V_{DS} = 15V, V_{GS} = -4.5V, I_D = -5A$ $V_{DS} = 15V, V_{GS} = -10V, I_D = -5A$
Gate-Source Charge	$Q_{gs}$	—	1.0	—		$V_{DS} = 15V, V_{GS} = -10V, I_D = -5A$
Gate-Drain Charge	$Q_{gd}$	—	2.5	—		$V_{DS} = 15V, V_{GS} = -10V, I_D = -5A$

Notes: 5. Short duration pulse test used to minimize self-heating effect.

**N-CHANNEL**

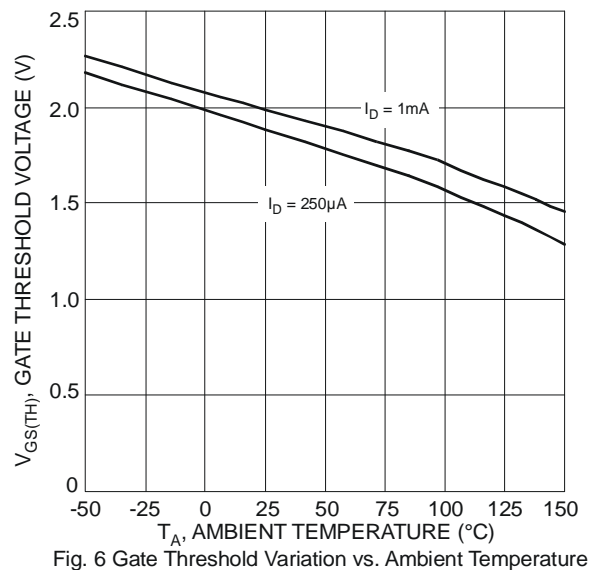
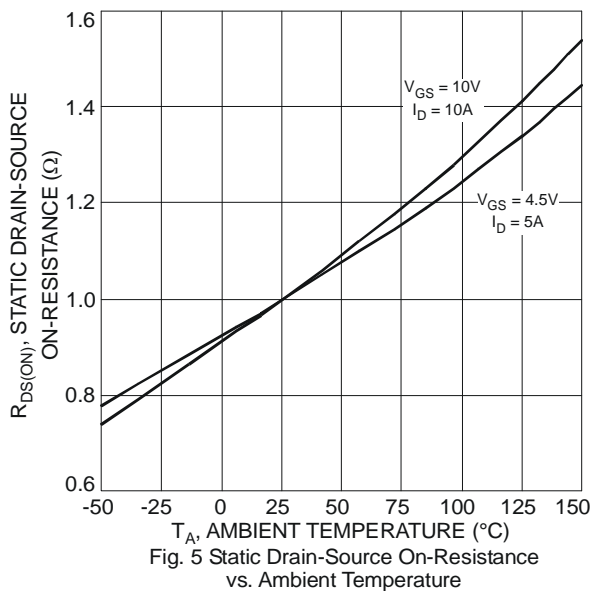
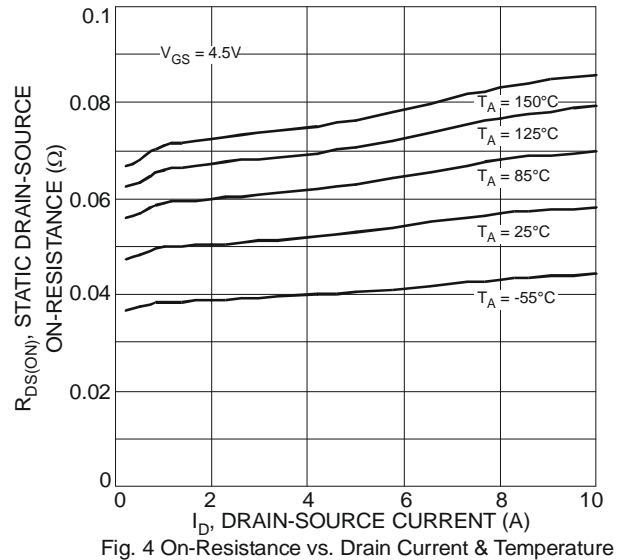
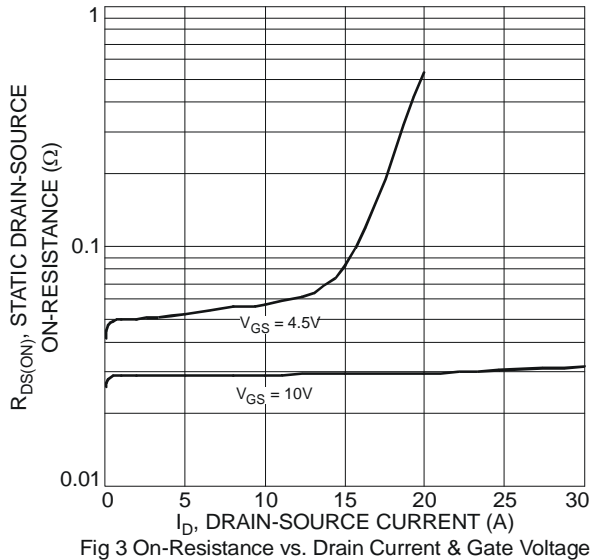
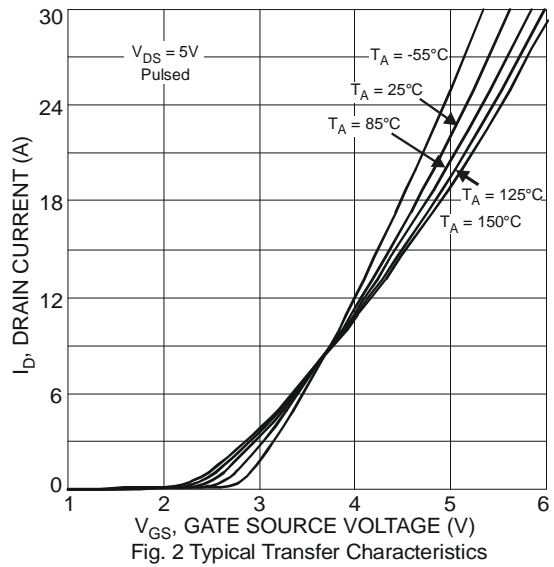
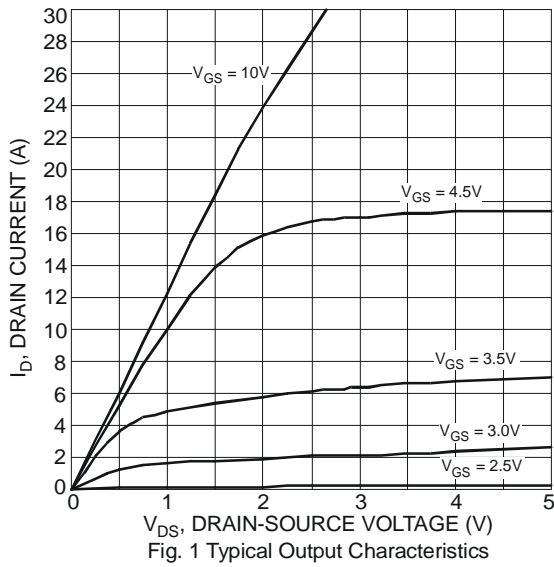

**N-CHANNEL (continued)**

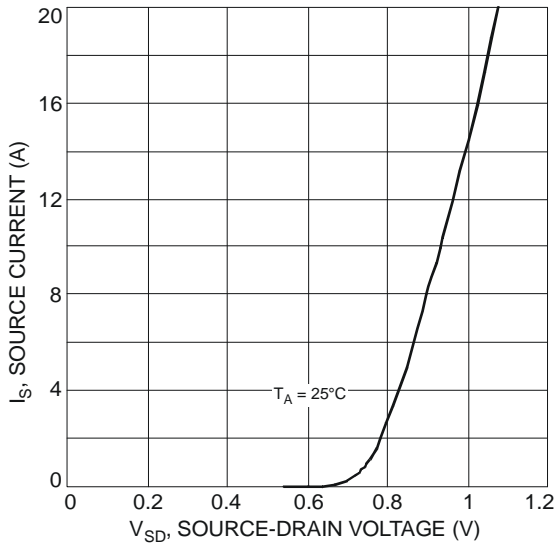

Fig. 7 Reverse Drain Current vs. Source-Drain Voltage

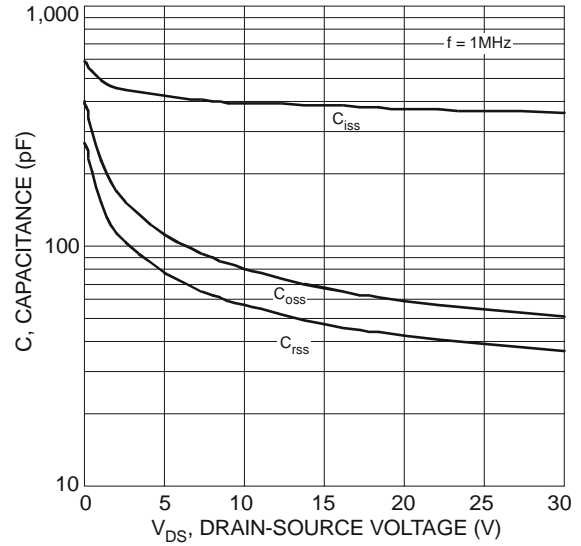

Fig. 8 Typical Total Capacitance

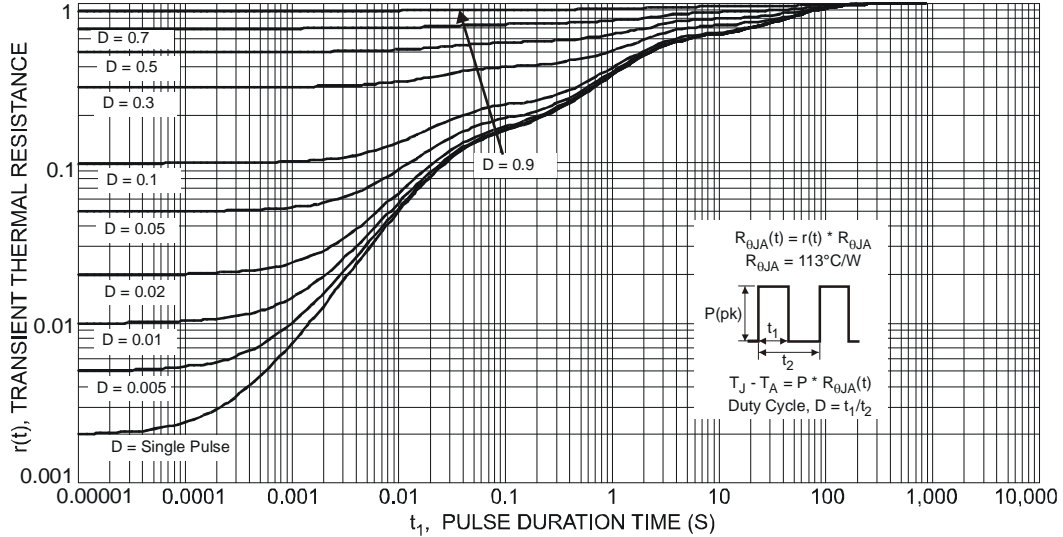

Fig. 9 Transient Thermal Resistance

**P-CHANNEL**

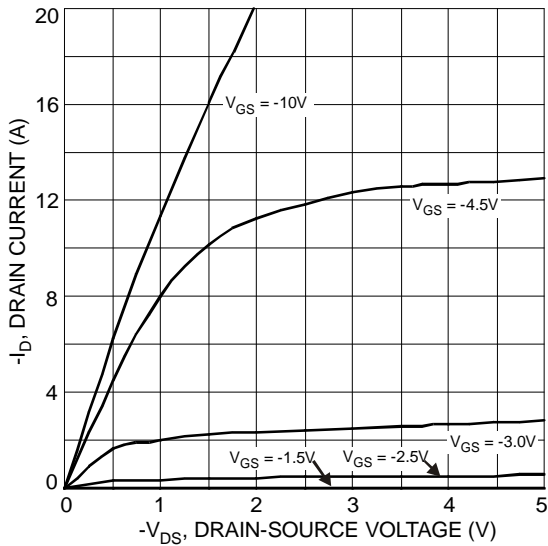

Fig. 10 Typical Output Characteristics

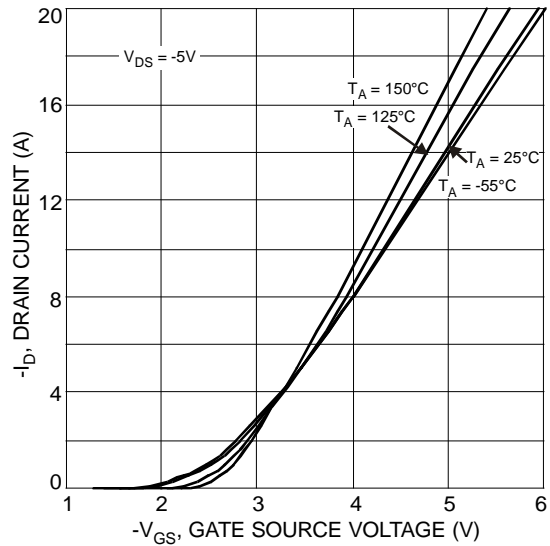

Fig. 11 Typical Transfer Characteristics

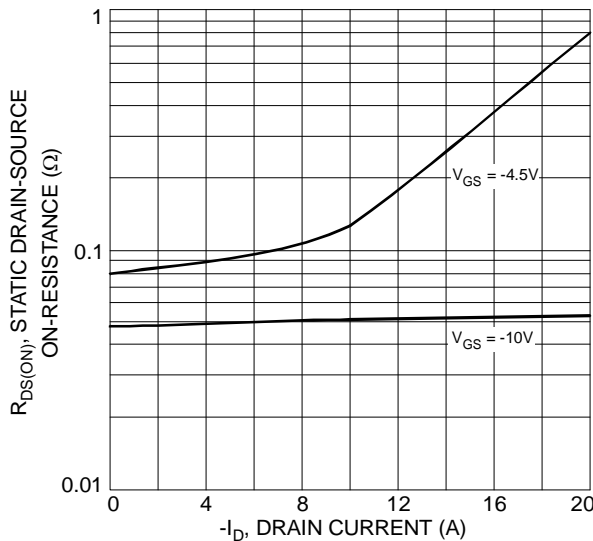

Fig. 12 Typical On-Resistance vs. Drain Current and Gate Voltage

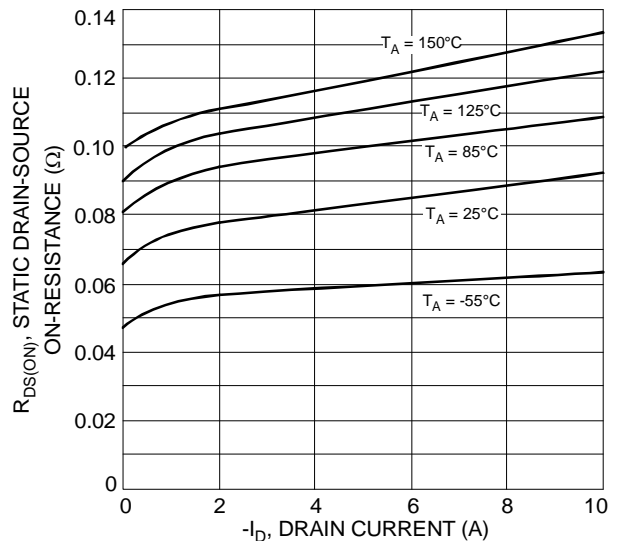

Fig. 13 Typical On-Resistance vs. Drain Current and Temperature

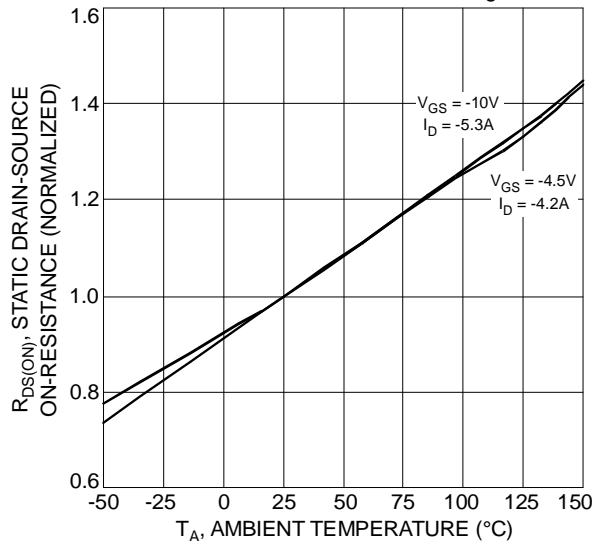

Fig. 14 On-Resistance Variation with Temperature

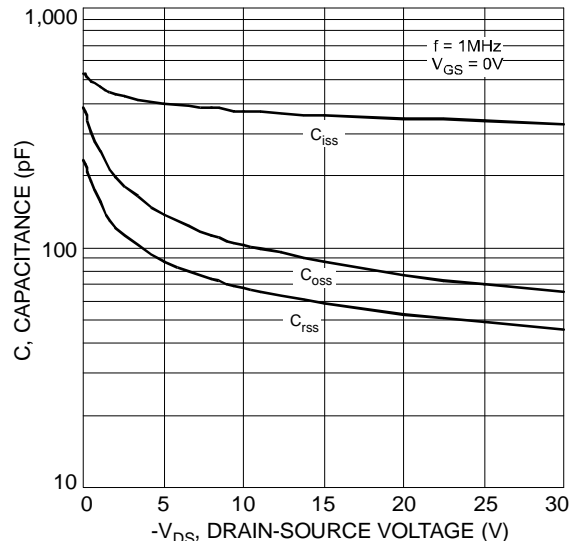

Fig. 15 Typical Capacitance

**P-CHANNEL (continued)**

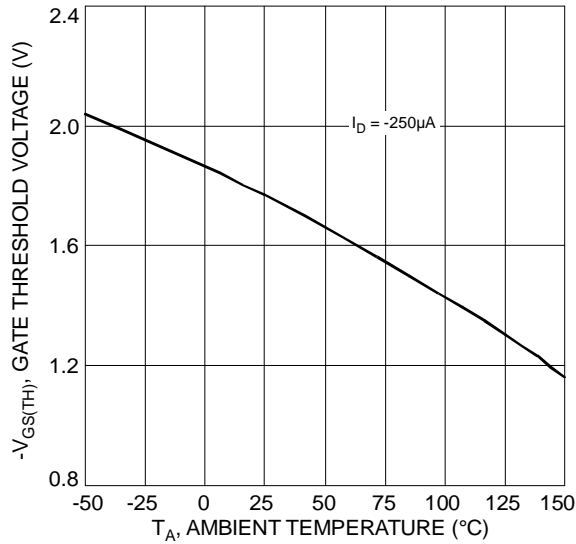

Fig. 16 Gate Threshold Variation vs. Ambient Temperature

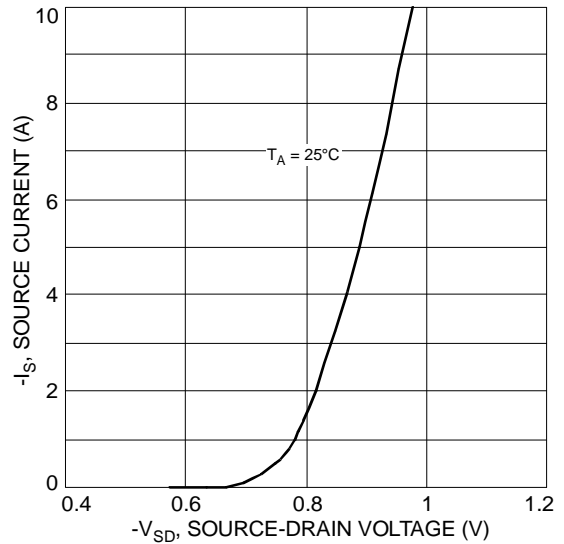

Fig. 17 Diode Forward Voltage vs. Current

**Ordering Information** (Note 6)

Part Number	Case	Packaging
DMC3035LSD-13	SOP-8L	2500/Tape & Reel

Notes: 6. For packaging details, go to our website at <http://www.diodes.com/datasheets/ap02007.pdf>.

**Marking Information**

( Top View )

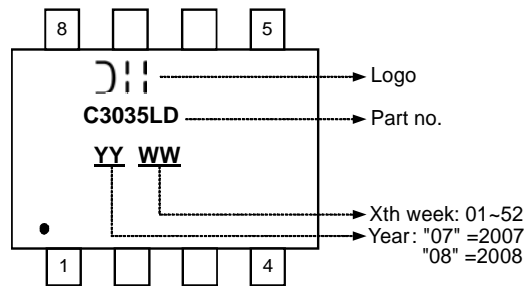

**Package Outline Dimensions**

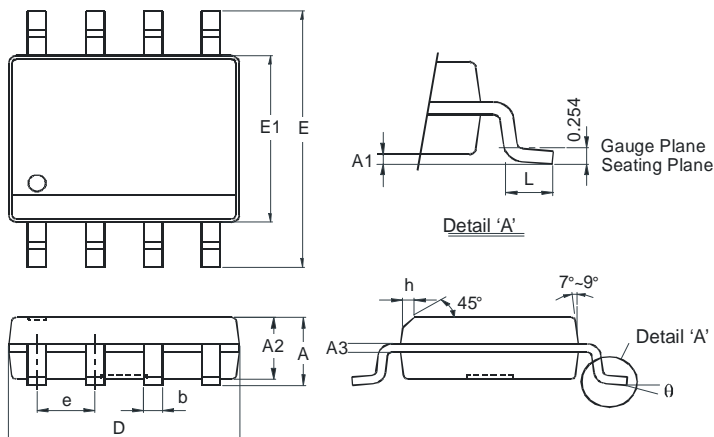

SOP-8L		
Dim	Min	Max
A	-	1.75
A1	0.08	0.25
A2	1.30	1.50
A3	0.20	Typ
b	0.3	0.5
D	4.80	5.30
E	5.79	6.20
E1	3.70	4.10
e	1.27	Typ
h	-	0.35
L	0.38	1.27
θ	0°	8°
<b>All Dimensions in mm</b>		

**Suggested Pad Layout**

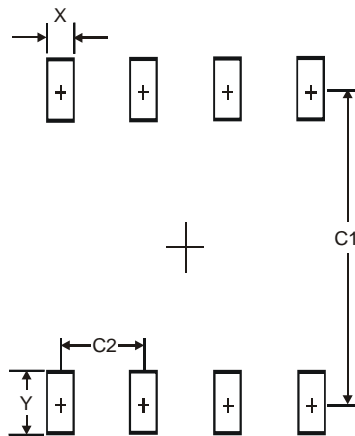

Dimensions	Value (in mm)
X	0.60
Y	1.55
C1	5.4
C2	1.27

**IMPORTANT NOTICE**

Diodes Incorporated and its subsidiaries reserve the right to make modifications, enhancements, improvements, corrections or other changes without further notice to any product herein. Diodes Incorporated does not assume any liability arising out of the application or use of any product described herein; neither does it convey any license under its patent rights, nor the rights of others. The user of products in such applications shall assume all risks of such use and will agree to hold Diodes Incorporated and all the companies whose products are represented on our website, harmless against all damages.

**LIFE SUPPORT**

Diodes Incorporated products are not authorized for use as critical components in life support devices or systems without the expressed written approval of the President of Diodes Incorporated.