

## Triple phase leg MOSFET Power Module

$V_{DSS} = 1000V$   
 $R_{DSon} = 350m\Omega \text{ typ @ } T_j = 25^\circ C$   
 $I_D = 22A @ T_c = 25^\circ C$

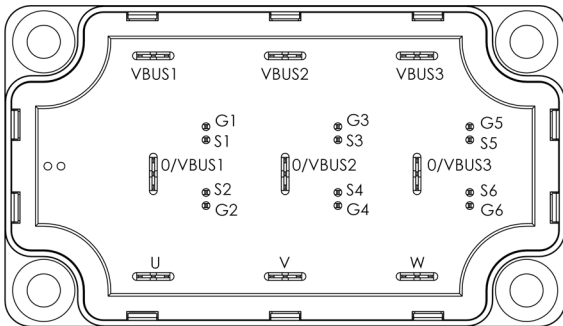
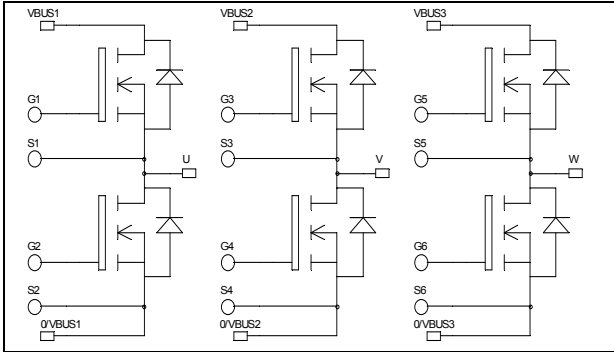

### Application

- Welding converters
- Switched Mode Power Supplies
- Uninterruptible Power Supplies
- Motor control

### Features

- Power MOS 7<sup>®</sup> FREDFETs
  - Low  $R_{DSon}$
  - Low input and Miller capacitance
  - Low gate charge
  - Fast intrinsic reverse diode
  - Avalanche energy rated
  - Very rugged
- Kelvin source for easy drive
- Very low stray inductance
  - Symmetrical design
  - Lead frames for power connections
- High level of integration

### Benefits

- Outstanding performance at high frequency operation
- Direct mounting to heatsink (isolated package)
- Low junction to case thermal resistance
- Solderable terminals both for power and signal for easy PCB mounting
- Very low (12mm) profile
- Each leg can be easily paralleled to achieve a phase leg of three times the current capability
- Module can be configured as a three phase bridge
- Module can be configured as a boost followed by a full bridge
- RoHS Compliant

### Absolute maximum ratings

Symbol	Parameter	Max ratings	Unit
$V_{DSS}$	Drain - Source Breakdown Voltage	1000	V
$I_D$	Continuous Drain Current	$T_c = 25^\circ C$	22
		$T_c = 80^\circ C$	17
$I_{DM}$	Pulsed Drain current	88	
$V_{GS}$	Gate - Source Voltage	$\pm 30$	V
$R_{DSon}$	Drain - Source ON Resistance	420	$m\Omega$
$P_D$	Maximum Power Dissipation	$T_c = 25^\circ C$	390
$I_{AR}$	Avalanche current (repetitive and non repetitive)	25	A
$E_{AR}$	Repetitive Avalanche Energy	50	mJ
$E_{AS}$	Single Pulse Avalanche Energy	3000	

**CAUTION:** These Devices are sensitive to Electrostatic Discharge. Proper Handling Procedures Should Be Followed. See application note APT0502 on [www.microsemi.com](http://www.microsemi.com)

All ratings @  $T_j = 25^\circ\text{C}$  unless otherwise specified

**Electrical Characteristics**

Symbol	Characteristic	Test Conditions	Min	Typ	Max	Unit
$I_{DSS}$	Zero Gate Voltage Drain Current	$V_{GS} = 0V, V_{DS} = 1000V$			100	$\mu\text{A}$
		$V_{GS} = 0V, V_{DS} = 800V$			500	
$R_{DS(on)}$	Drain – Source on Resistance	$V_{GS} = 10V, I_D = 11A$		350	420	$\text{m}\Omega$
$V_{GS(th)}$	Gate Threshold Voltage	$V_{GS} = V_{DS}, I_D = 2.5\text{mA}$	3		5	V
$I_{GSS}$	Gate – Source Leakage Current	$V_{GS} = \pm 30V, V_{DS} = 0V$			$\pm 100$	$\text{nA}$

**Dynamic Characteristics**

Symbol	Characteristic	Test Conditions	Min	Typ	Max	Unit
$C_{iss}$	Input Capacitance	$V_{GS} = 0V$ $V_{DS} = 25V$ $f = 1\text{MHz}$		5.2		$\text{nF}$
$C_{oss}$	Output Capacitance			0.88		
$C_{rss}$	Reverse Transfer Capacitance			0.16		
$Q_g$	Total gate Charge	$V_{GS} = 10V$ $V_{Bus} = 500V$ $I_D = 22A$		186		$\text{nC}$
$Q_{gs}$	Gate – Source Charge			24		
$Q_{gd}$	Gate – Drain Charge			122		
$T_{d(on)}$	Turn-on Delay Time	<b>Inductive switching @ 125°C</b> $V_{GS} = 15V$ $V_{Bus} = 670V$ $I_D = 22A$ $R_G = 5\Omega$		18		$\text{ns}$
$T_r$	Rise Time			12		
$T_{d(off)}$	Turn-off Delay Time			155		
$T_f$	Fall Time			40		
$E_{on}$	Turn-on Switching Energy	<b>Inductive switching @ 25°C</b> $V_{GS} = 15V, V_{Bus} = 670V$ $I_D = 22A, R_G = 5\Omega$		900		$\mu\text{J}$
$E_{off}$	Turn-off Switching Energy			623		
$E_{on}$	Turn-on Switching Energy	<b>Inductive switching @ 125°C</b> $V_{GS} = 15V, V_{Bus} = 670V$ $I_D = 22A, R_G = 5\Omega$		1423		$\mu\text{J}$
$E_{off}$	Turn-off Switching Energy			779		

**Source - Drain diode ratings and characteristics**

Symbol	Characteristic	Test Conditions	Min	Typ	Max	Unit	
$I_S$	Continuous Source current (Body diode)	$T_c = 25^\circ\text{C}$			22	A	
		$T_c = 80^\circ\text{C}$			17		
$V_{SD}$	Diode Forward Voltage	$V_{GS} = 0V, I_S = -22A$			1.3	V	
dv/dt	Peak Diode Recovery ①				18	V/ns	
$t_{rr}$	Reverse Recovery Time	$I_S = -22A$ $V_R = 670V$ $di_S/dt = 100A/\mu\text{s}$	$T_j = 25^\circ\text{C}$			320	$\text{ns}$
			$T_j = 125^\circ\text{C}$			650	
$Q_{rr}$	Reverse Recovery Charge	$I_S = -22A$ $V_R = 670V$ $di_S/dt = 100A/\mu\text{s}$	$T_j = 25^\circ\text{C}$		3.6	$\mu\text{C}$	
			$T_j = 125^\circ\text{C}$		9.72		

① dv/dt numbers reflect the limitations of the circuit rather than the device itself.

$$I_S \leq -22A \quad di/dt \leq 700A/\mu\text{s} \quad V_R \leq V_{DSS} \quad T_j \leq 150^\circ\text{C}$$

**Thermal and package characteristics**

Symbol	Characteristic	Min	Typ	Max	Unit	
R <sub>thJC</sub>	Junction to Case Thermal Resistance			0.32	°C/W	
V <sub>ISOL</sub>	RMS Isolation Voltage, any terminal to case t=1 min, 50/60Hz	4000			V	
T <sub>J</sub>	Operating junction temperature range	-40		150	°C	
T <sub>STG</sub>	Storage Temperature Range	-40		125		
T <sub>C</sub>	Operating Case Temperature	-40		100		
Torque	Mounting torque	To heatsink	M6	3	5	N.m
Wt	Package Weight				250	g

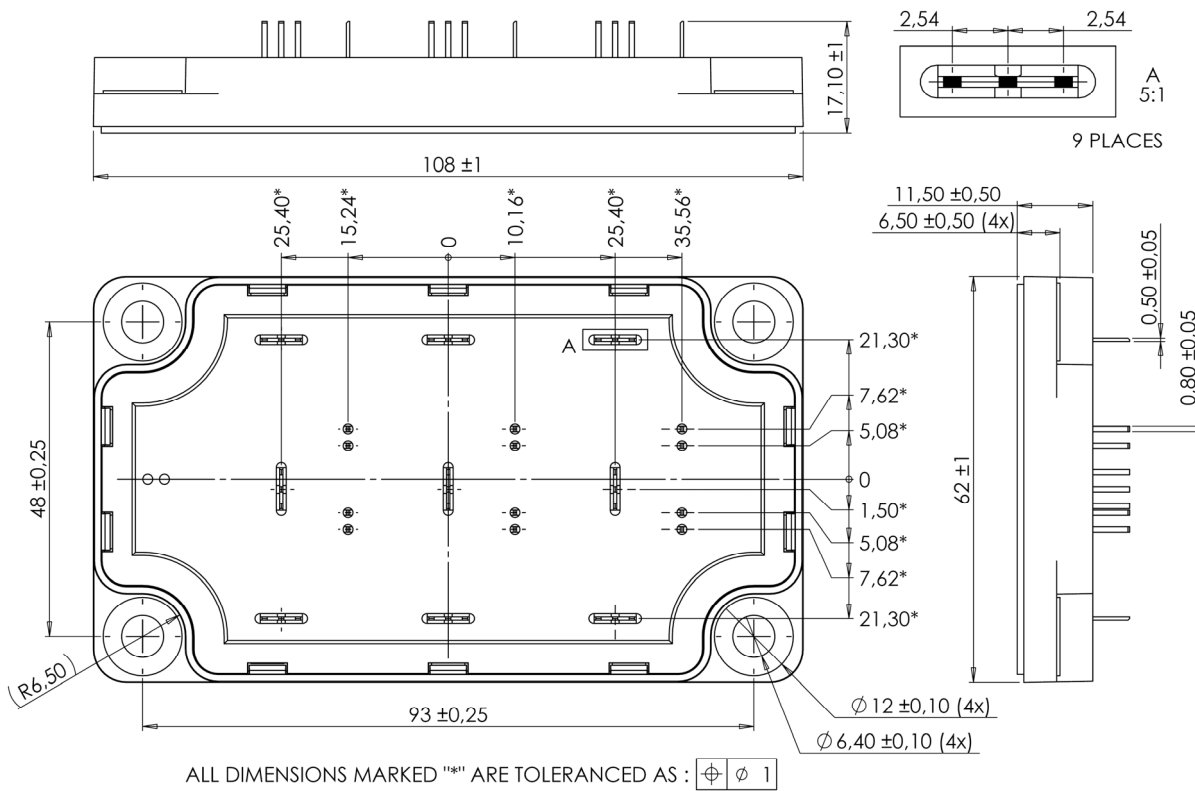
**SP6-P Package outline (dimensions in mm)**

See application note 1902 - Mounting Instructions for SP6-P (12mm) Power Modules on [www.microsemi.com](http://www.microsemi.com)

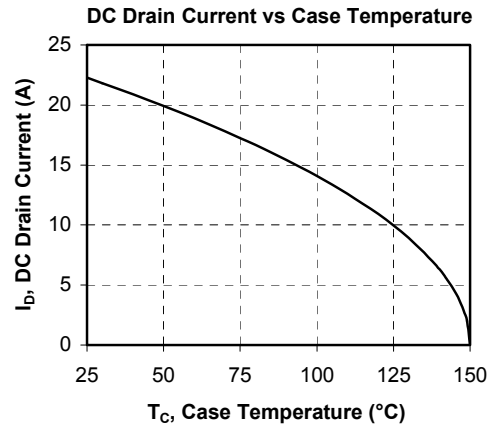
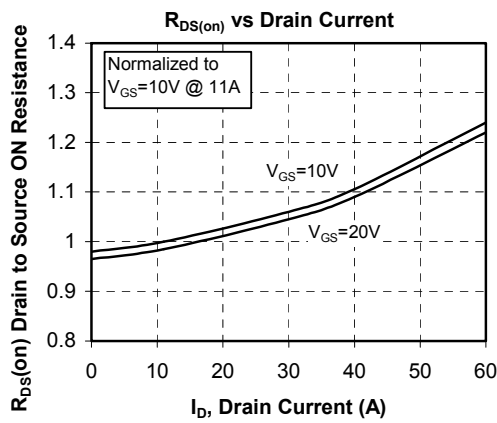
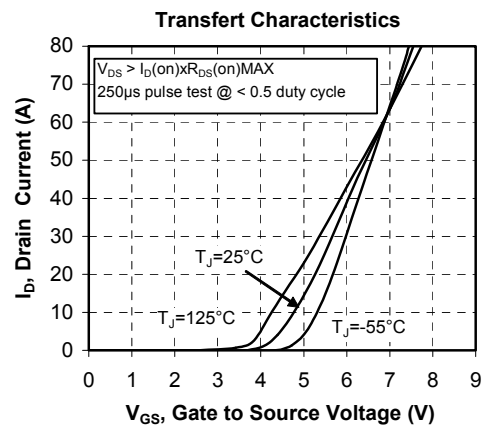
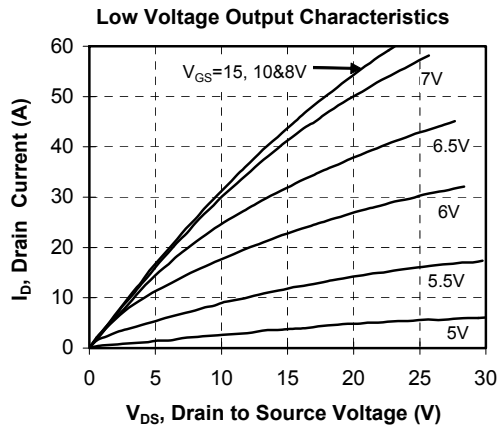
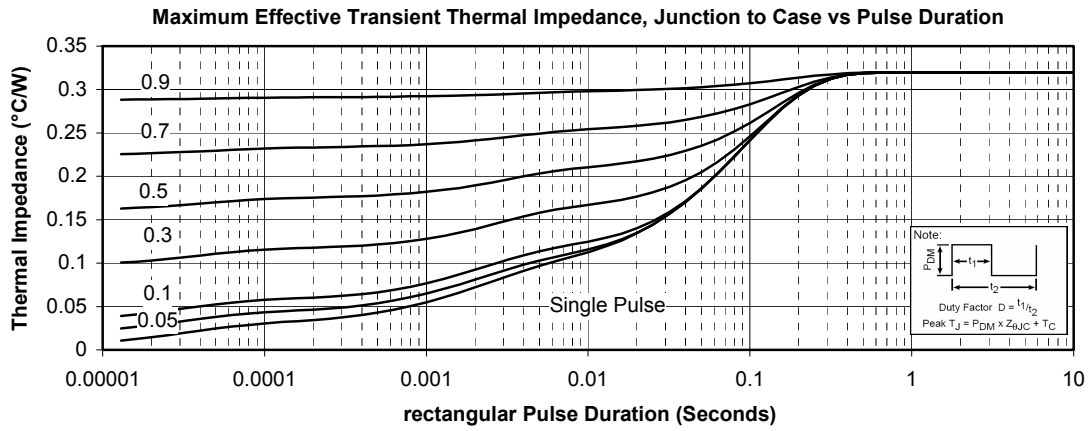
**Typical Performance Curve**

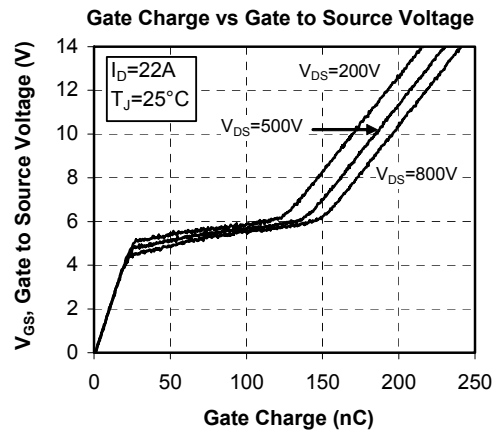
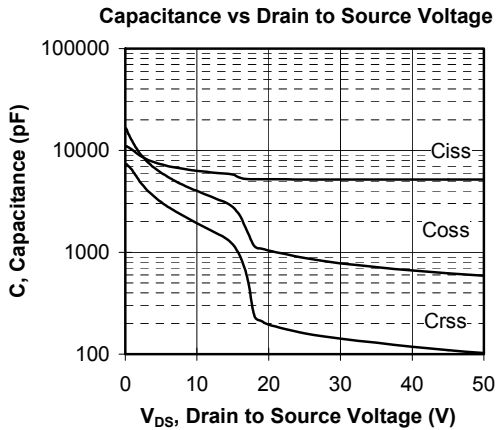
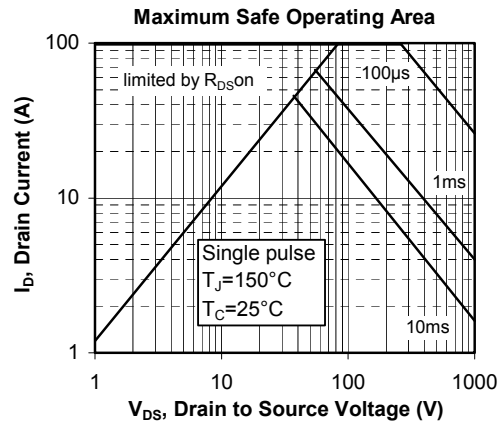
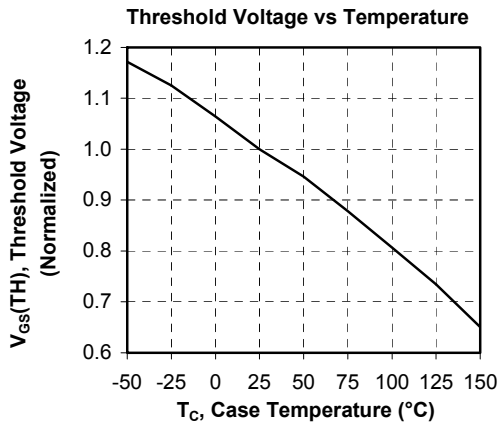
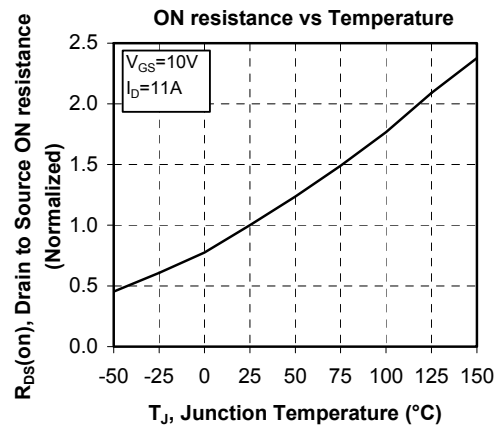
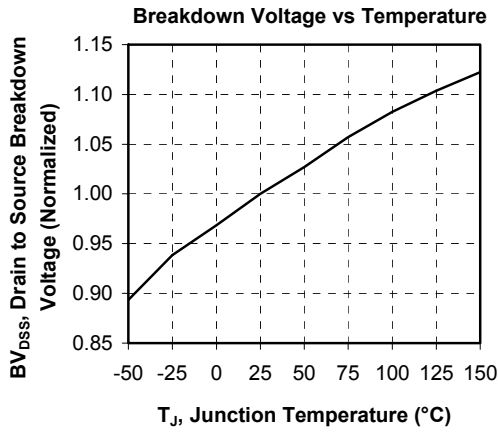

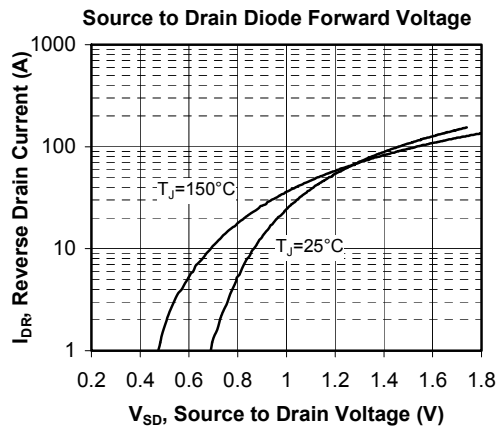
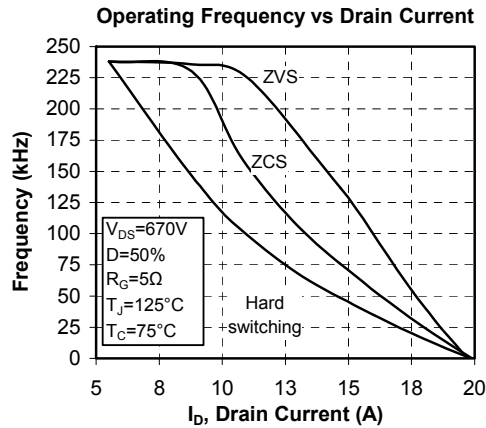
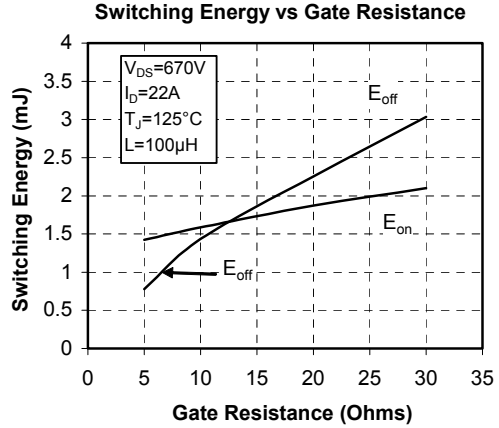
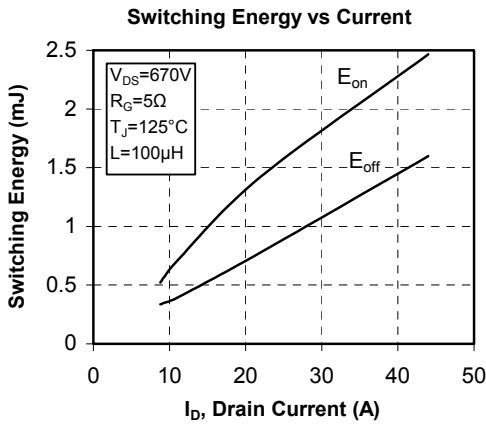
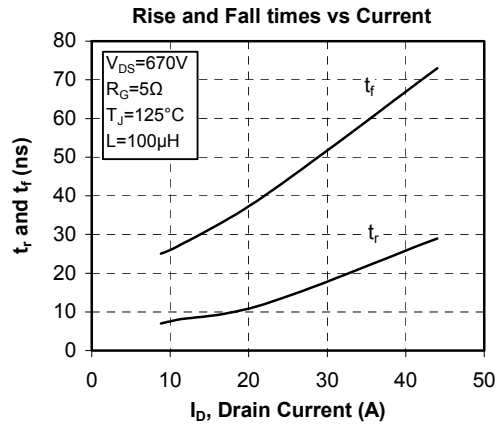
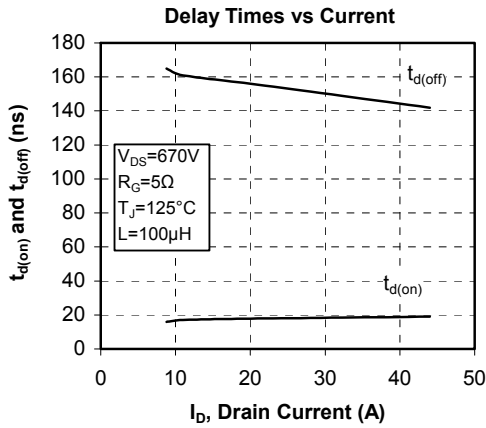

## DISCLAIMER

The information contained in the document (unless it is publicly available on the Web without access restrictions) is PROPRIETARY AND CONFIDENTIAL information of Microsemi and cannot be copied, published, uploaded, posted, transmitted, distributed or disclosed or used without the express duly signed written consent of Microsemi. If the recipient of this document has entered into a disclosure agreement with Microsemi, then the terms of such Agreement will also apply. This document and the information contained herein may not be modified, by any person other than authorized personnel of Microsemi. No license under any patent, copyright, trade secret or other intellectual property right is granted to or conferred upon you by disclosure or delivery of the information, either expressly, by implication, inducement, estoppels or otherwise. Any license under such intellectual property rights must be approved by Microsemi in writing signed by an officer of Microsemi.

Microsemi reserves the right to change the configuration, functionality and performance of its products at anytime without any notice. This product has been subject to limited testing and should not be used in conjunction with life-support or other mission-critical equipment or applications. Microsemi assumes no liability whatsoever, and Microsemi disclaims any express or implied warranty, relating to sale and/or use of Microsemi products including liability or warranties relating to fitness for a particular purpose, merchantability, or infringement of any patent, copyright or other intellectual property right. Any performance specifications believed to be reliable but are not verified and customer or user must conduct and complete all performance and other testing of this product as well as any user or customers final application. User or customer shall not rely on any data and performance specifications or parameters provided by Microsemi. It is the customer's and user's responsibility to independently determine suitability of any Microsemi product and to test and verify the same. The information contained herein is provided "AS IS, WHERE IS" and with all faults, and the entire risk associated with such information is entirely with the User. Microsemi specifically disclaims any liability of any kind including for consequential, incidental and punitive damages as well as lost profit. The product is subject to other terms and conditions which can be located on the web at <http://www.microsemi.com/legal/tnc.asp>

### Life Support Application

Seller's Products are not designed, intended, or authorized for use as components in systems intended for space, aviation, surgical implant into the body, in other applications intended to support or sustain life, or for any other application in which the failure of the Seller's Product could create a situation where personal injury, death or property damage or loss may occur (collectively "Life Support Applications").

Buyer agrees not to use Products in any Life Support Applications and to the extent it does it shall conduct extensive testing of the Product in such applications and further agrees to indemnify and hold Seller, and its officers, employees, subsidiaries, affiliates, agents, sales representatives and distributors harmless against all claims, costs, damages and expenses, and attorneys' fees and costs arising, directly or indirectly, out of any claims of personal injury, death, damage or otherwise associated with the use of the goods in Life Support Applications, even if such claim includes allegations that Seller was negligent regarding the design or manufacture of the goods.

Buyer must notify Seller in writing before using Seller's Products in Life Support Applications. Seller will study with Buyer alternative solutions to meet Buyer application specification based on Seller's sales conditions applicable for the new proposed specific part.